



WATERWAVE

**POOL & SPA
PRODUCT CATALOGUE**

PROFESSIONAL MANUFACTURER & GLOBAL SUPPLIER

2026

www.waterwaveglobal.com

LETTER FROM MANAGEMENT

Dear Pool Owners, Builders, and Enthusiasts,

*We're excited to introduce **Waterwave** — a new brand born from a simple idea: Pool systems should be simpler, smarter, and more sustainable.*

For years, we've seen pool owners and installers face the same challenges: inconsistent product quality, confusing specifications, and short lifespans that drive up maintenance costs. So, we wanted to create a better way.

At Waterwave, we design and supply reliable, high-performance pool products — from pumps and filters to accessories — built with durability and clarity in mind. Every product is tested to meet real-world conditions in tropical climates, ensuring you get consistent performance, clean water, and peace of mind.

But beyond equipment, our mission is about trust. We aim to build long-term partner ships with our customers — offering honest advice, accessible support, and continuous improvement in everything we supply.

Thank you for your support and confidence as we ride this wave into this new chapter together.

We are just getting started, and we would love for you to be part of our journey. Explore our first line of pool products, share your feedback, and help us shape the next wave of quality in water systems.

Yours Sincerely,

 WATERWAVE



WHOLE GOODS DIRECTORY

PUMPS 1-14

Eco-Flow Series.....	1-2
Titan-Flow Series.....	3-4
AquaFlow Series.....	5-6
AquaCore Series.....	7-8
Vars-Flow Series.....	9-10
Aqua Master Series.....	11-12
Aqua Endurance Series.....	13-14

FILTERS 15-30

Profiber Top Series.....	15-16
Profiber Side Series.....	17-18
Flowmaster Series.....	19-20
Aquatitan Series.....	21-23
Hydro Pure Series.....	24
HydroMax Pro DE Filter Series.....	25-26
Regenerative Media Filtration System.....	27-30

LIGHTS 31-51

Lumiwave Color Series.....	31-48
LumiBrite Pro Series.....	49-51

ACCESSORIES 52-69

Aquacore Series.....	52-59
Aquaskim Series.....	60-64
Aquaedge Series.....	65-68
Cascade Pro Series.....	69

MAINTENANCE EQUIPMENT 70-75

Proclean Series.....	70-71
Easyclean Series.....	72-74
Automatic Robot Series.....	75

SANITIZERS 76-79

Aquasalt Series.....	76
Uvflow Series.....	77
Intellichem Series.....	78
Intellidose Series.....	79

WELLNESS 80-115

Harvia Sauna Series.....	80-82
Timbertherm Series.....	83-85
Harvia Steam Series.....	86-89
Steam Flow Series.....	90-92
Hydrotherapy WH Series.....	93-109
Aquafit Evolution Series.....	110-112
Aqua Motion Series.....	113-115

COMPETITION ACCESSORY 116-118

ProAqua Elite Series.....	116-118
---------------------------	---------

SAFETY COVER 119-123

Slatted Pool Cover.....	119
Integrated Pool Cover.....	120
Flexible Pool Cover.....	121
Pool Deck Cover.....	122
Elevating Pool Cover.....	123

MODULAR PANEL POOL 124-127

CONVERSION TABLE 128

 WATERWAVE

PUMPS



- ◆ ECO-FLOW SERIES
- ◆ TITAN-FLOW SERIES
- ◆ AQUAFLOW SERIES
- ◆ AQUACORE SERIES
- ◆ VARS-FLOW SERIES
- ◆ AQUA MASTER SERIES
- ◆ AQUA ENDURANCE SERIES

ECO-FLOW SERIES

QUIET FULL-FLOW PERFORMANCE FOR POOLS & SPAS

Featured Highlights

- Pump inlet and outlet reinforced with stainless-steel rings
- TI.USA thermal protector
- Insulation class F
- Maximum suction lift: 2.5 m
- Protection rating: IP55
- Integrated handle for easy installation



Ordering Information

Product	Description	Voltage	Hertz	Amps	HP	Port Size Inch	Carton Wt	Curve Key
SINGLE PHASE 220 - 240V								
01010101	EF050	220-240	50	1.9	0.50	1.5" / 50mm	9.6	A
01010102	EF075	220-240	50	2.7	0.75	1.5" / 50mm	10.7	B
01010103	EF100	220-240	50	3.8	1.00	1.5" / 50mm	11.3	C
01010104	EF120	220-240	50	4.6	1.20	1.5" / 50mm	12.5	D
01010105	EF150	220-240	50	5.8	1.50	1.5" / 50mm	13.0	E
01010106	EF200	220-240	50	7.0	2.00	1.5" / 50mm	13.8	F

Note: Models in 230V/60Hz and 110V/60Hz configurations are available upon request.

WORKING CONDITIONS
▲ Medium temperature: 5-50°C
▲ Ambient temperature: ≤50°C
▲ Maximum working pressure: 0.3 MPa

ECO-FLOW SERIES

QUIET FULL-FLOW PERFORMANCE FOR POOLS & SPAS

Performance

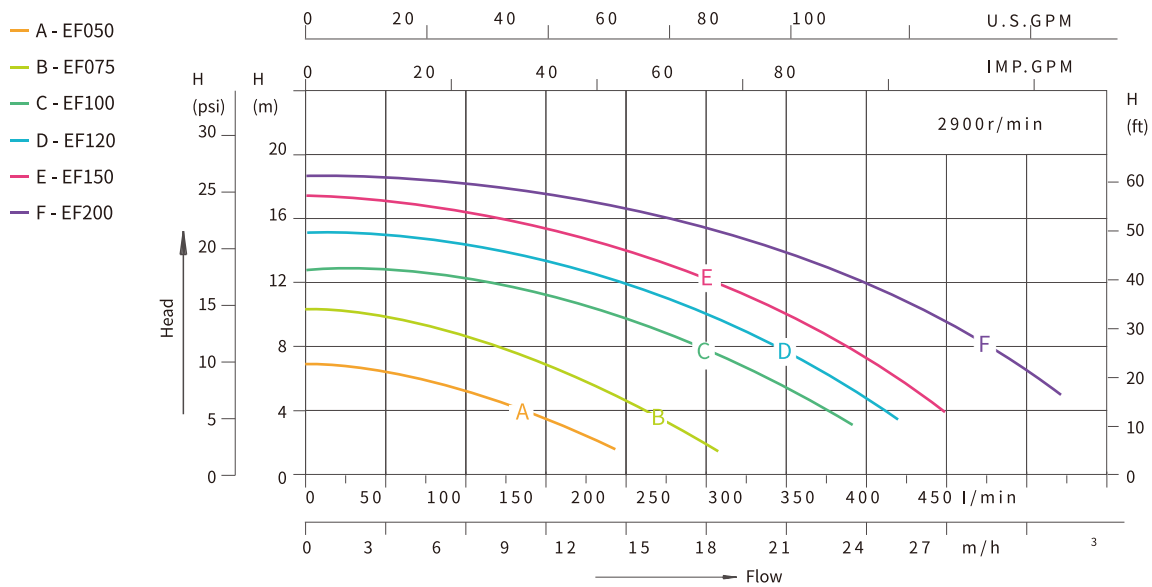

Dimensions (mm)

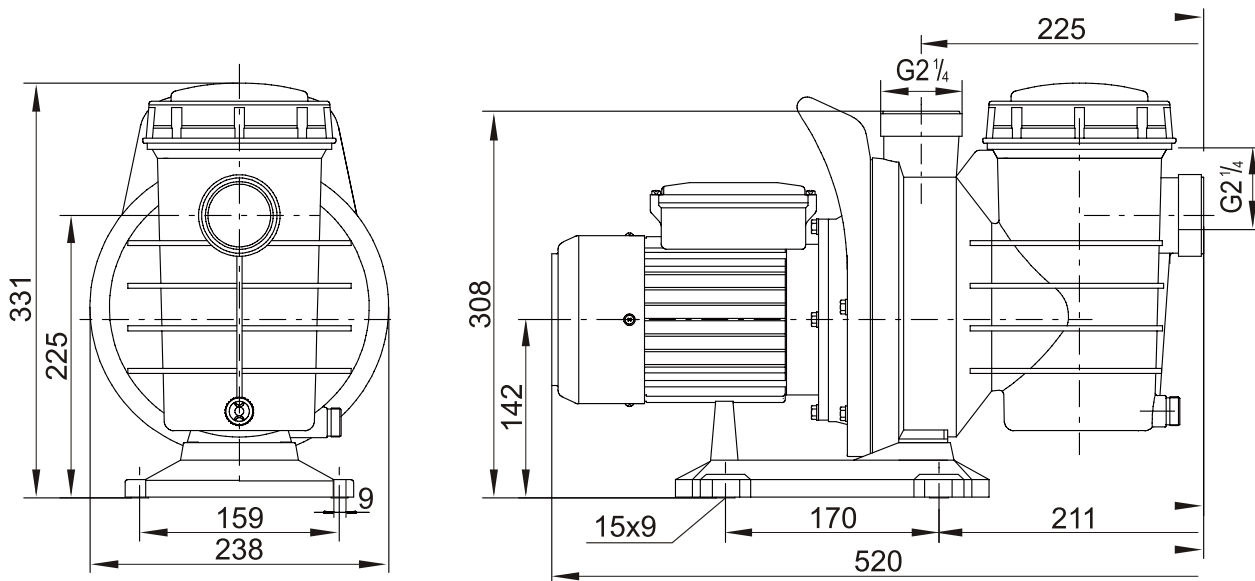

TITAN-FLOW SERIES

QUIET FULL-FLOW PERFORMANCE FOR POOLS & SPAS



Featured Highlights

- Pump inlet and outlet reinforced with stainless-steel rings
- TI.USA thermal protector
- Insulation class F
- Maximum suction lift: 3.0 m
- Protection rating: IP55
- Integrated handle for easy installation

Ordering Information

Product	Description	Voltage	Hertz	Amps	HP	Port Size Inch	Carton Wt	Curve Key
SINGLE PHASE 220 - 240V								
01010201	TF075	220-240	50	3.2	0.75	2.0" / 63mm	14.6	A
01010202	TF100	220-240	50	3.8	1.00	2.0" / 63mm	15.5	B
01010203	TF120	220-240	50	4.6	1.20	2.0" / 63mm	16.3	C
01010204	TF150	220-240	50	5.2	1.50	2.0" / 63mm	17.3	D
01010205	TF200	220-240	50	7.0	2.00	2.0" / 63mm	18.3	E
01010206	TF250	220-240	50	8.6	2.50	2.0" / 63mm	20.4	F
01010207	TF300	220-240	50	10.0	3.00	2.0" / 63mm	21.6	G

Note: Models in 230V/60Hz and 110V/60Hz configurations are available upon request.

WORKING CONDITIONS

- ▲ Medium temperature: 5-50°C
- ▲ Ambient temperature: ≤50°C
- ▲ Maximum working pressure: 0.3 MPa

TITAN-FLOW SERIES

QUIET FULL-FLOW PERFORMANCE FOR POOLS & SPAS

Performance

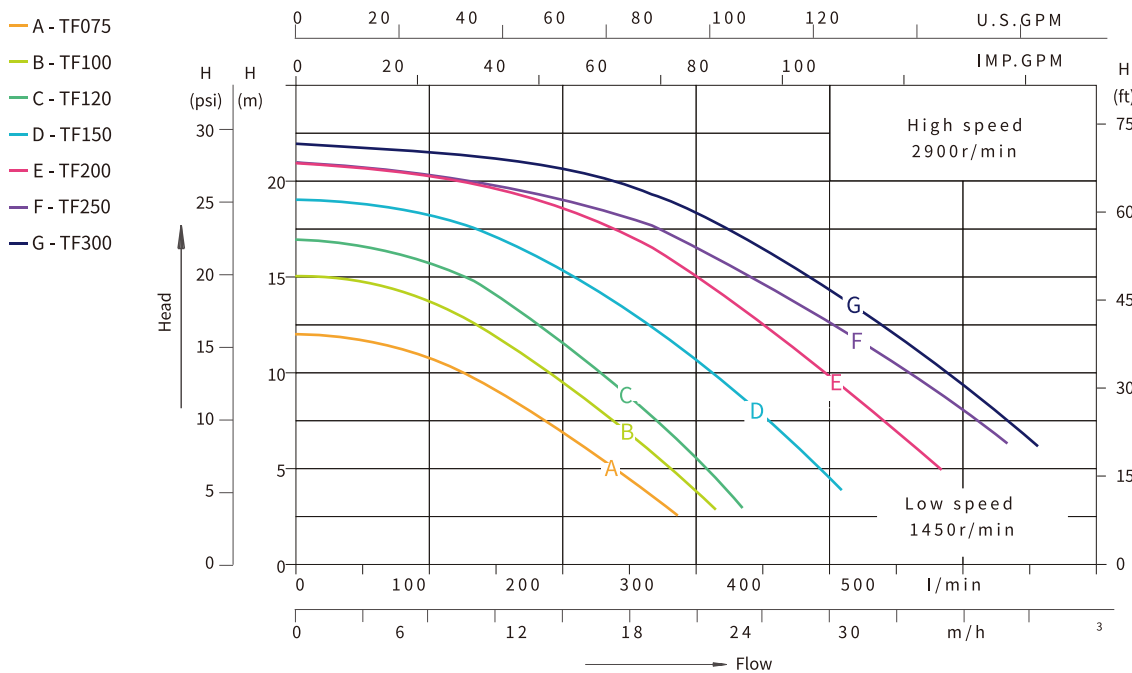

Dimensions (mm)

MODEL	H
01010201	243
01010202	243
01010203	243
01010204	243
01010205	246
01010206	258
01010207	258

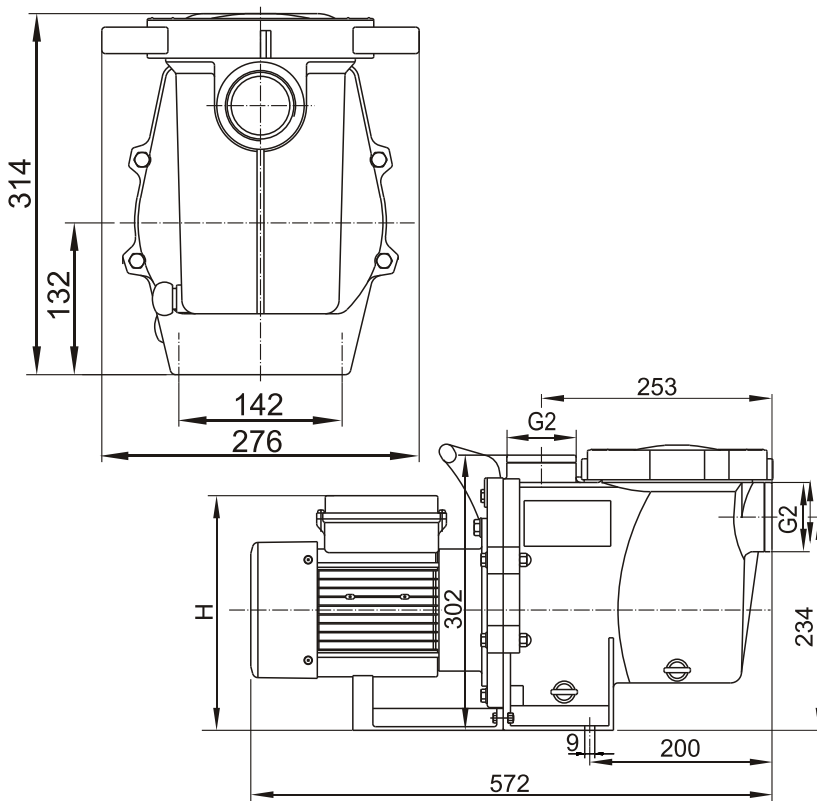

AQUAFLOW PRO SERIES

HIGH-EFFICIENCY POOL & SPA PUMP

Featured Highlights

- Rugged, one-piece strainer housing molded from corrosion-resistant reinforced thermo-plastic for durability and long service life
- Exclusive high-performance motor design for quieter, cooler, and more energy-efficient operation
- Special clear lid with a locking ring for easy access; large strainer basket remains securely in place
- American-design mechanical seal with carbon-to-ceramic sealing surfaces
- Self-priming up to 1.8 m
- Fully factory-tested



Ordering Information

Product	Description	Voltage	Hertz	Amps	HP	Port Size Inch	Carton Wt	Curve Key
SINGLE PHASE 220 - 240V								
01010301	HF075	220-240	50	3.5	0.75	1.5" / 50mm	9.8	A
01010302	HF100	220-240	50	4.5	1.00	1.5" / 50mm	11.8	B
01010303	HF150	220-240	50	6.4	1.50	1.5" / 50mm	13.4	C

Note: Models in 230V/60Hz and 110V/60Hz configurations are available upon request.

WORKING CONDITIONS

- ⚠ Medium temperature: 5–50°C
- ⚠ Ambient temperature: ≤50°C
- ⚠ Maximum working pressure: 0.3 MPa

AQUAFLOW PRO SERIES

HIGH-EFFICIENCY POOL & SPA PUMP

Performance

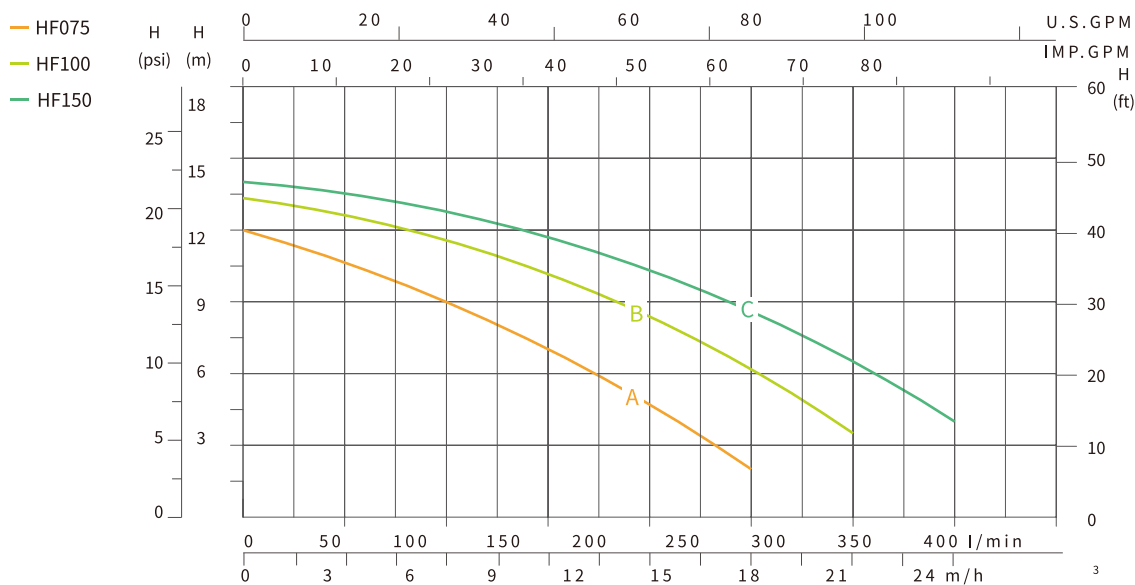

Dimensions (mm)

MODEL	L	A
01010301	281	527.5
01010302	316	562.5
01010303	316	562.5

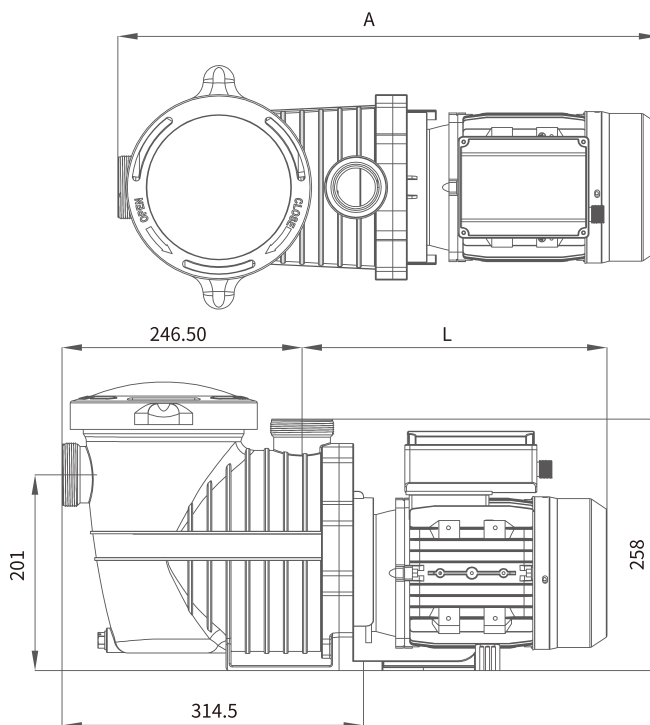
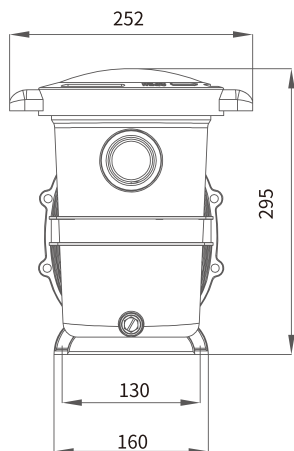

AQUACORE PERFORMANCE SERIES

HIGH-EFFICIENCY POOL & SPA PUMP



WORKING CONDITIONS	
⚠	Medium temperature: 5-50°C
⚠	Ambient temperature: ≤50°C
⚠	Maximum working pressure: 0.3 MPa

Featured Highlights

- Innovative diffuser and high-efficiency impeller maximize water flow and energy efficiency while reducing noise and operating costs
- All components are molded from corrosion-resistant reinforced thermoplastic for superior durability and long service life
- Special clear lid with a locking ring for easy access; large strainer basket remains securely in place
- Heavy-duty, high-performance motor ensures quieter and cooler operation
- Transparent lid allows quick visual inspection; engineered polymer remains clear and durable. The lid is easy to remove and locks securely with a quarter-turn
- Extra-large strainer basket for simplified maintenance
- American-design mechanical seal with carbon-to-ceramic sealing surfaces
- Fully factory-tested

Ordering Information

Product	Description	Voltage	Hertz	Amps	HP	Port Size Inch	Carton Wt	Curve Key
SINGLE PHASE 220 - 240V								
01010401	AC100	220-240	50	4.5	1.00	2.0" / 63mm	13.5	A
01010402	AC150	220-240	50	6.5	1.50	2.0" / 63mm	15.1	B

Note: Models in 230V/60Hz and 110V/60Hz configurations are available upon request.

AQUACORE PERFORMANCE SERIES

HIGH-EFFICIENCY POOL & SPA PUMP

Performance

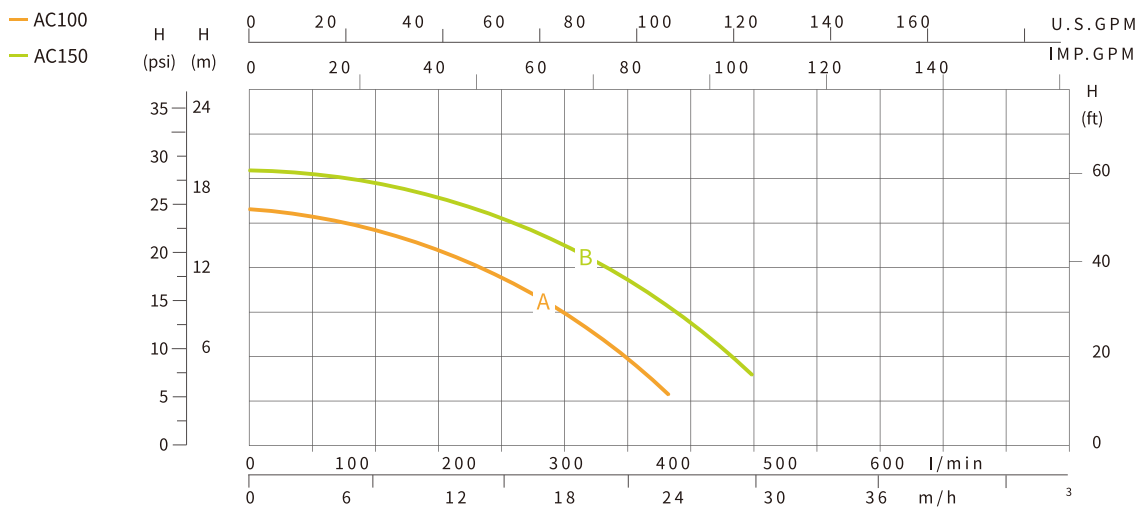

Dimensions (mm)

MODEL	L	A
01010401	331	611
01010402	331	611

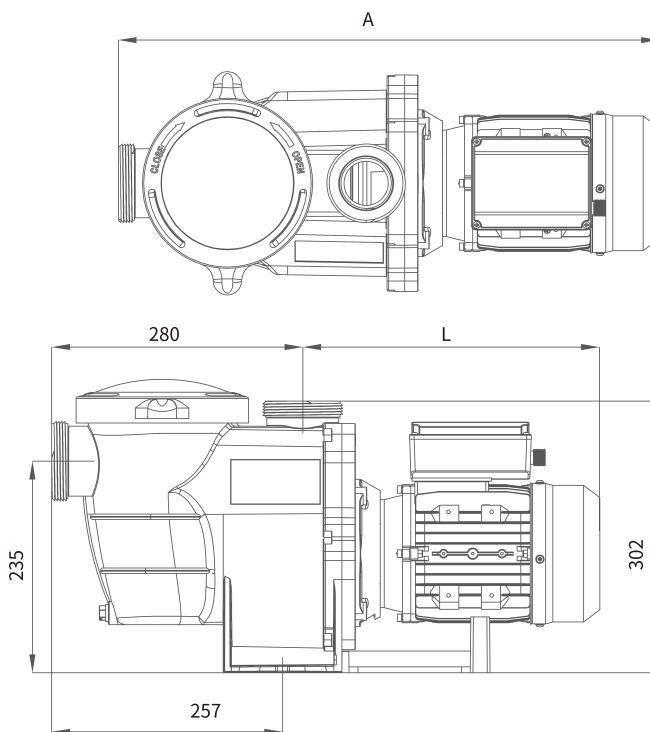
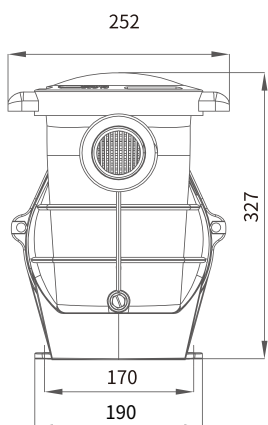

VARF-FLOW PUMP SERIES

ENGINEERED FOR RELIABILITY, SILENCE AND LONG SERVICE LIFE

Featured Highlights

- Pump inlet and outlet reinforced with stainless-steel rings
- Using a V/F mode controller, the single-speed pump can be operated with variable-speed control. A touch key panel or physical key panel is optional. The design is streamlined, with simple operating logic, and the installation orientation can be rotated
- Both automatic and manual modes are available, with automatic mode as the factory default
Factory-set pump speeds in automatic mode:
Level 1: 3000 rpm
Level 2: 1400 rpm
Level 3: 2200 rpm
- Speeds can be adjusted freely between 450–3450 rpm using the speed-level keys
- In manual mode, the user may select any speed level and adjust the corresponding speed
- The pump can be controlled either through an external keypad or via an RS485 communication interface (only one option can be used at a time)
- High efficiency and energy-saving
- Electronic protection



WORKING CONDITIONS	
⚠	Medium temperature: 5–50°C
⚠	Ambient temperature: ≤50°C
⚠	Maximum working pressure: 0.3 MPa

Ordering Information

Product	Description	Voltage	Hertz	Amps	HP	Port Size Inch	Carton Wt /kg	Curve Key
01020101	VFPV390	230	50/60	13	3.90	2.0" / 63mm	23.6	A

VARs-FLOW PUMP SERIES

ENGINEERED FOR RELIABILITY, SILENCE AND LONG SERVICE LIFE

Performance

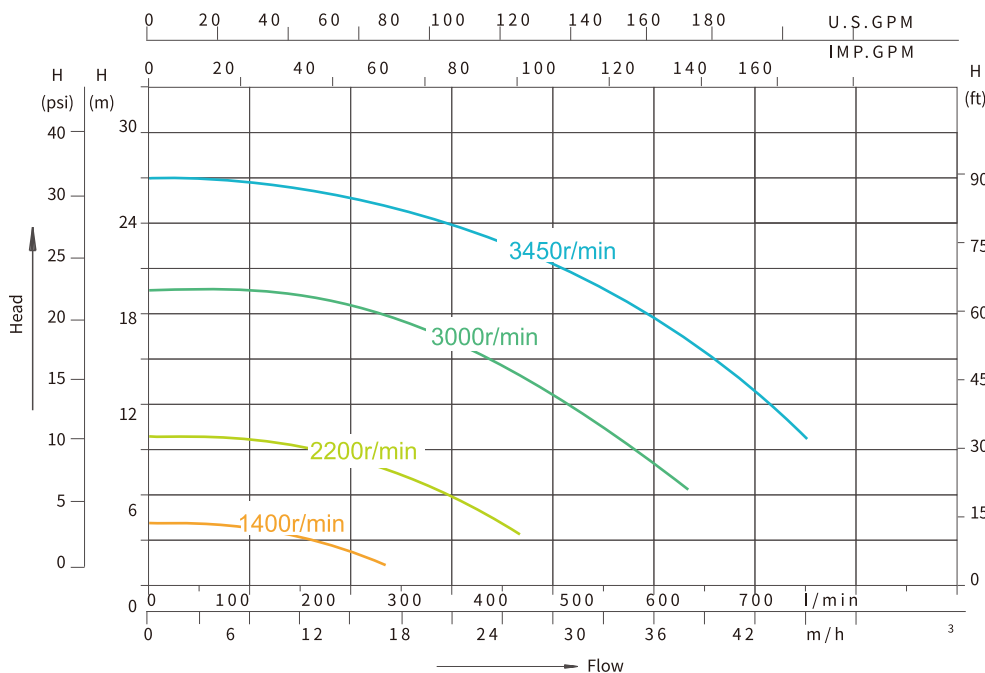

Dimensions (mm)

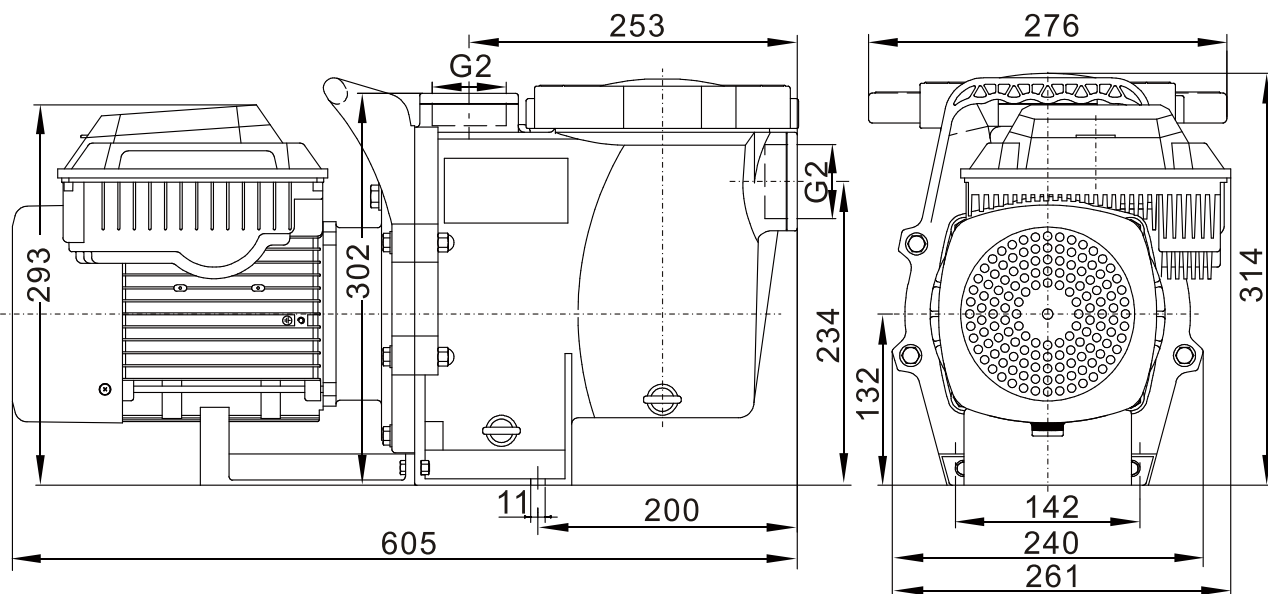

AQUA MASTER SERIES

COMMERCIAL HIGH-FLOW PUMP SERIES



Featured Highlights

- Inlet and outlet flanges comply with Chinese national standard DN150 and are also compatible with ANSI B16.5 flange standards
- Supplied with an integrated plastic mounting base; optional cast-aluminum feet available
- Equipped with a high-efficiency motor for energy savings and extended service life
- Capable of long-term safe operation with media temperatures up to 75°C, suitable for natural hot spring circulation
- Ideal for large water parks, aquariums, and medium to large swimming pool circulation and filtration systems

Ordering Information

Product	Description	Voltage	Hertz	Amps	HP	Port Size Inch	Carton Wt	Curve Key
01030101	AM400	380	50	5.9	4.00	DN150(6")	88.5	A
01030102	AM500	380	50	6.8	5.00	DN150(6")	88.5	B
01030103	AM750	380	50	10.3	7.50	DN150(6")	91.5	C
01030104	AM1000	380	50	12.7	10.00	DN150(6")	95.0	D
01030105	AM1500	380	50	20.1	15.00	DN150(6")	129.0	E
01030106	AM2000	380	50	26.7	20.00	DN150(6")	137.0	F
01030107	AM2500	380	50	30.3	25.00	DN150(6")	144.0	G

Note: Models in 380V/60Hz, are available upon request

WORKING CONDITIONS

- ▲ Medium temperature: 0-75°C
- ▲ Ambient temperature: ≤50°C
- ▲ Maximum working pressure: 0.7MPa

AQUA MASTER SERIES

COMMERCIAL HIGH-FLOW PUMP SERIES

Performance

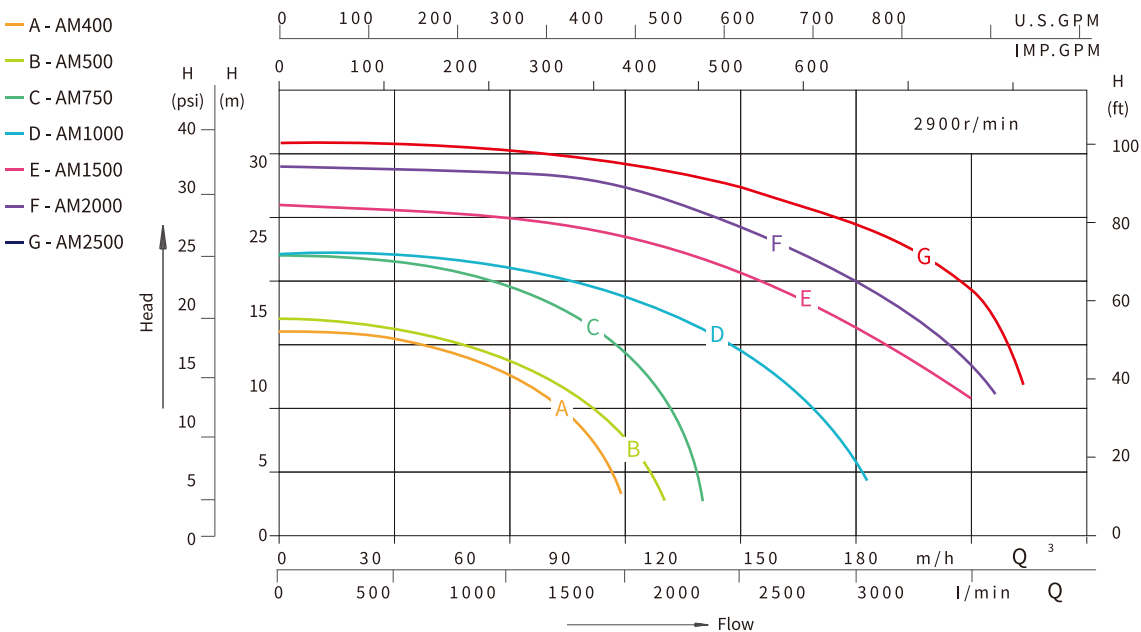

Dimensions(mm)

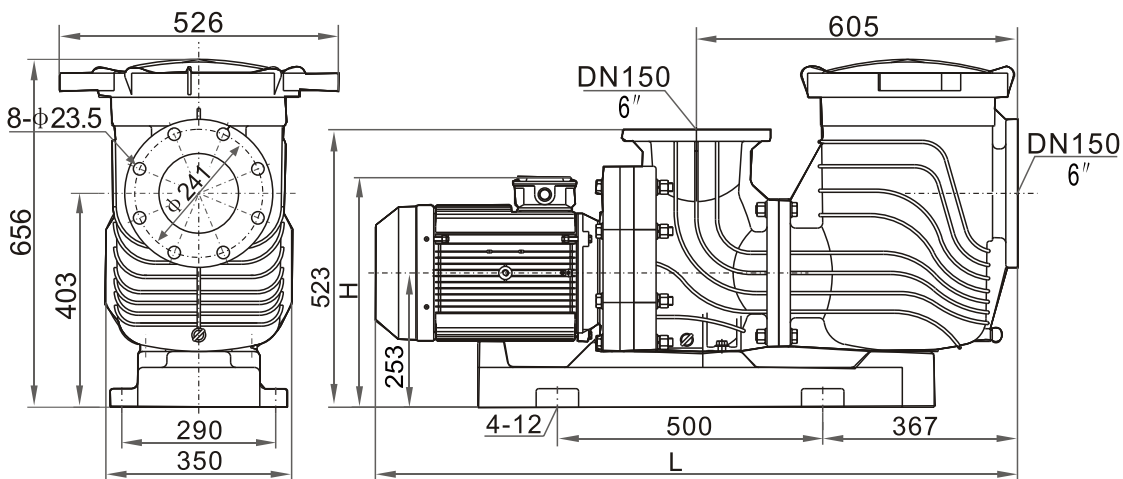

MODEL	L	H
01030101	1155	414
01030102	1155	414
01030103	1155	414
01030104	1155	414
01030105	1210	433
01030106	1251	433
01030107	1251	433

AQUA ENDURANCE SERIES

POOL SUBMERSIBLE PUMPS

Featured Highlights

- Suitable for fresh water, seawater, and wastewater
- Used for water supply, drainage, water circulation, and water exchange in agriculture, forestry, and aquaculture
- Applicable to landscape fish ponds, decorative waterfalls, and filtration drainage systems
- High efficiency, energy saving, robust, and durable



Ordering Information (mm)

Product	Description	Voltage	Hertz	Amps	HP	Port Size Inch	Carton Wt	Curve Key
SINGLE PHASE 220 - 240V								
01040101	AE150-50	220-240	50	1.1	150.00	50.0	8.5	A
01040102	AE200-50	220-240	50	1.5	200.00	50.0	8.5	B
01040103	AE400-50	220-240	50	2.9	400.00	50.0	9.5	C
01040104	AE400-80	220-240	50	2.9	400.00	80.0	15.0	D
01040105	AE400-100	220-240	50	2.9	400.00	100.0	16.2	E

Note: Models in 110V/60Hz, 230V/60Hz and 110V/60Hz configurations are available upon request.

WORKING CONDITIONS

- ⚠ Medium temperature: 0-40°C
- ⚠ Submersion depth: ≤ 5m

AQUA ENDURANCE SERIES

POOL SUBMERSIBLE PUMPS

Performance

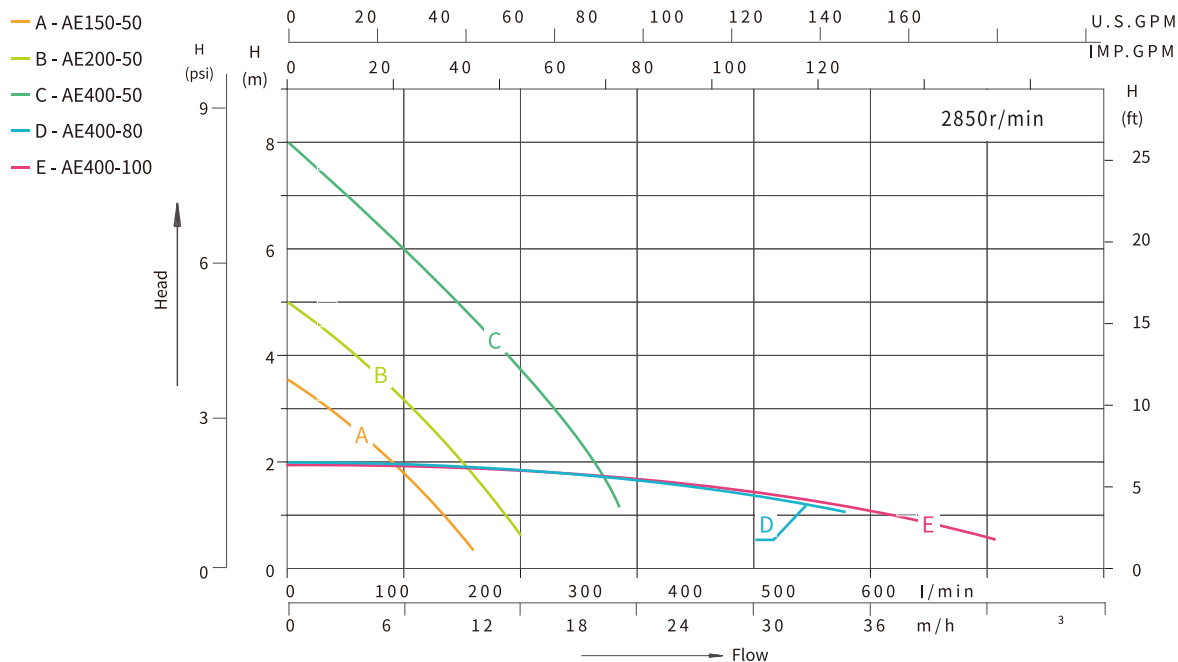

Dimensions(mm)

MODEL	SHAPE SIZE (MM)					
	L	L1	H	H1	W	D
01040101	239	120	372	201	160	51
01040102	239	120	372	201	160	51
01040103	239	120	372	201	160	51
01040104	265	126	375	190	185	76
01040105	317	150	383	247	210	102

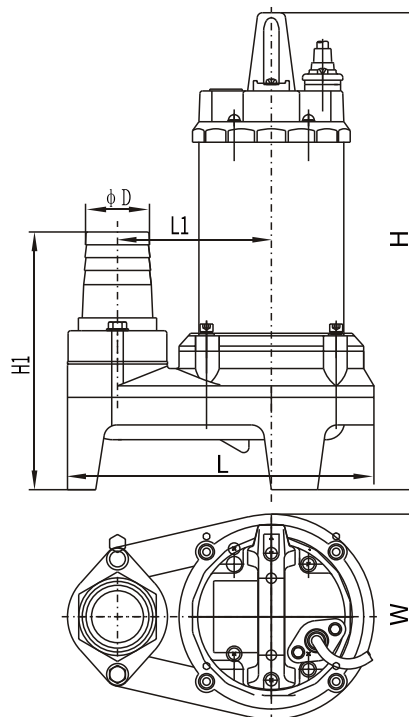

 WATERWAVE

FILTERS

- ◆ PROFIBER TOP SERIES
- ◆ PROFIBER SIDE SERIES
- ◆ FLOWMASTER SERIES
- ◆ AQUATITAN SERIES
- ◆ HYDRO PURE SERIES
- ◆ HYDROMAX PRO DE FILTER SERIES
- ◆ ULTRAPURE REGENERATIVE FILTER SERIES

PROFIBER TOP SERIES

HIGH-PRESSURE, DURABLE FIBER-WOUND FILTER TANKS FOR POOLS & SPAS

Featured Highlights

- Vacuum-formed tank liner for superior durability
- Removable neck ring for easy service and lower maintenance cost
- UV-protected, fiberglass-reinforced tank body
- Combined sand and water drain for better frost-crack resistance
- Clear viewing window for filtration inspection
- Tight top-mount valve integration for reliable sealing



Ordering Information

Product	Model	Effective Filtration Area Sq.Ft (M ²)	Flow Rate GPM(M ³ /H)	Port Size Size	All Sand Required Lbs.(Kg)
02010101	PFT16	1.4 (0.13)	26 (6)	1.5" / 50mm	66 (30)
02010102	PFT18	1.7 (0.16)	35 (8)	1.5" / 50mm	99 (45)
02010103	PFT20	2.4 (0.22)	48 (11)	1.5" / 50mm	176 (80)
02010104	PFT26	3.5 (0.32)	66 (15)	1.5" / 50mm	331 (150)
02010105	PFT28	4.1 (0.38)	84 (19)	1.5" / 50mm	463 (210)
02010106	PFT32	5.4 (0.50)	110 (25)	2.0" / 63mm	573 (260)
02010107	PFT36	6.9 (0.64)	141 (32)	2.0" / 63mm	882 (400)
02010108	PFT40	8.5 (0.79)	158 (36)	2.0" / 63mm	1323 (600)
02010109	PFT44	10.2 (0.95)	189 (43)	2.0" / 63mm	1764 (800)
02010110	PFT48	12.2 (1.13)	225 (51)	2.0" / 63mm	1984 (900)
02010111	PFT56	16.7 (1.5)	299 (68)	2.0" / 63mm	3086 (1400)

WORKING CONDITIONS

- ▲ Maximum Working: 250 kPa / 36 psi (2.5 bar) 400Kpa/58psi(4.0bar)
- ▲ Maximum Temperature: 50°C (122°F)
- ▲ Maximum Test Pressure: 400 kPa / 58 psi (4.0 bar) 600Kpa/87psi(6.0bar)
- ▲ Recommended Media Size: 0.5mm ~ 0.8mm(Sand)

PROFIBER TOP SERIES

HIGH-PRESSURE, DURABLE FIBER-WOUND FILTER
TANKS FOR POOLS & SPAS

Dimensions

Model	PFT16	PFT18	PFT20	PFT26	PFT28	PFT32	PFT36	PFT40	PFT44	PFT48	PFT56
ØD(mm)	400	450	530	630	700	800	900	1000	1100	1200	1400
H(mm)	770	815	870	935	1005	1130	1270	1340	1460	1540	1750
A(mm)	520	565	620	685	755	830	970	1040	1160	1240	1450
B(mm)	73	75	75	95	95	150	150	150	180	180	180
M(mm)	629	674	729	794	864	962	1112	1182	1302	1392	1592
N(mm)	570	615	670	735	805	882	1032	1102	1222	1312	1512
ØP(mm)	315	390	390	565	565	790	790	790	1010	1010	1010
T(mm)	160	230	260	350	440	490	500	580	600	750	900

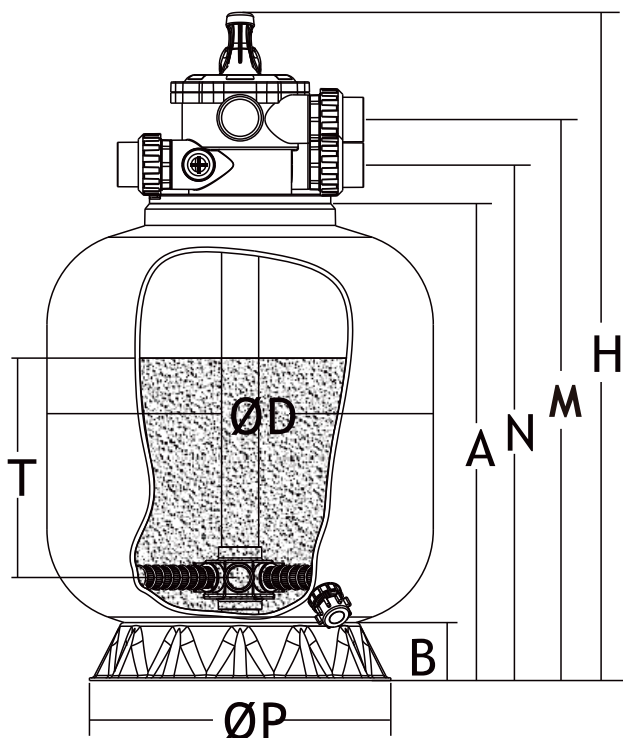

PROFIBER SIDE SERIES

HIGH-PRESSURE, DURABLE FIBER-WOUND FILTER TANKS FOR POOLS & SPAS



Featured Highlights

- Vacuum-formed tank liner for superior durability
- Removable neck ring for easy service and lower maintenance cost
- UV-protected, fiberglass-reinforced tank body
- Combined sand and water drain for better frost-crack resistance
- Clear viewing window for filtration inspection
- Screw-type sand filters install more securely and tightly

Ordering Information

Product	Model	Effective Filtration Area Sq.Ft. (M ²)	Flow Rate GPM (M ³ /H)(GPM)	Port Size Size	All Sand Required Lbs.(Kg)
02010201	PFS18	1.7 (0.16)	35 (8)	1.5" / 50mm	110 (50)
02010202	PFS20	2.2 (0.20)	44 (10)	1.5" / 50mm	187 (85)
02010203	PFS26	3.4 (0.32)	66 (15)	1.5" / 50mm	297 (135)
02010204	PFS28	4.1 (0.38)	83 (19)	1.5" / 50mm	440 (200)
02010205	PFS32	5.4 (0.50)	110 (25)	2.0" / 63mm	573 (260)
02010206	PFS36	6.9 (0.64)	140 (32)	2.0" / 63mm	881 (400)
02010207	PFS40	8.5 (0.79)	158 (36)	2.0" / 63mm	1322 (600)
02010208	PFS44	10.2 (0.95)	189 (43)	2.0" / 63mm	1763 (800)
02010209	PFS48	12.2 (1.13)	224 (51)	2.0" / 63mm	2028 (920)

WORKING CONDITIONS

- ▲ Maximum Operating Pressure: 250 kPa / 36 psi (2.5 bar) 400Kpa/58psi(4.0bar)
- ▲ Maximum Temperature: 50°C (122°F)
- ▲ Maximum Test Pressure: 400 kPa / 58 psi (4.0 bar) 600Kpa/87psi(6.0bar)
- ▲ Recommended Media Size: 0.5–0.8 mm quartz sand

PROFIBER SIDE SERIES

HIGH-PRESSURE, DURABLE FIBER-WOUND FILTER
TANKS FOR POOLS & SPAS

Dimensions

Model	PFS18	PFS20	PFS26	PFS28	PFS32	PFS36	PFS40	PFS44	PFS48
ØD(mm)	450	530	635	700	800	900	1000	1100	1200
H(mm)	665	720	785	855	980	1070	1190	1300	1380
A(mm)	260	280	310	360	385	430	540	650	650
B(mm)	75	75	95	95	150	150	150	180	180
C(mm)	125	125	125	125	220	220	220	220	220
ØP(mm)	390	390	565	565	790	790	790	1010	1010
T(mm)	250	280	300	350	410	480	510	560	600

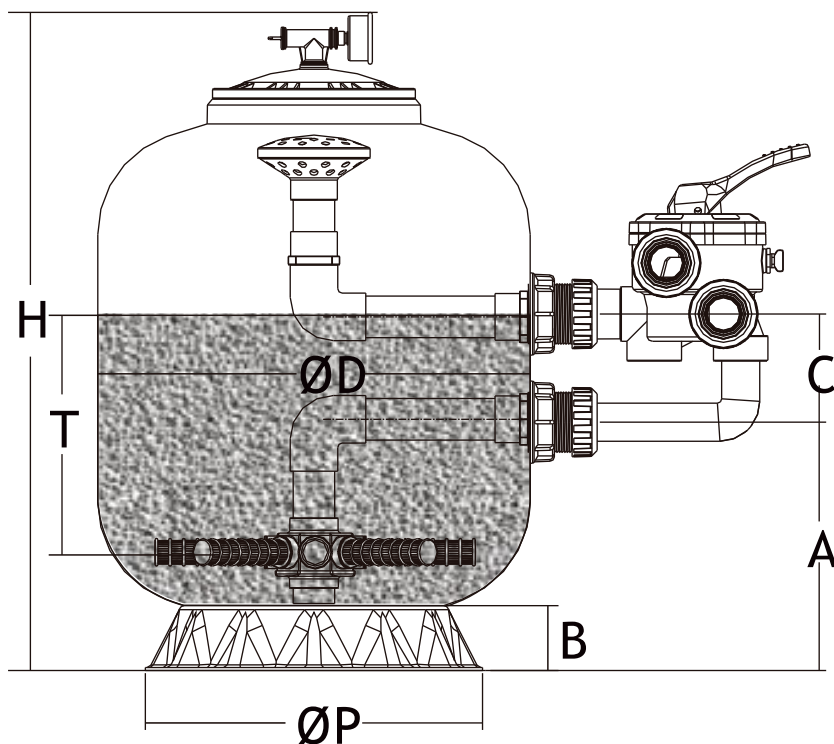

FLOWMASTER SERIES

LARGE-DIAMETER, HIGH-FLOW FILTER TANKS FOR COMMERCIAL POOLS VALVE

Featured Highlights

- Flexible Internal Collection Options
Available with collector arms or collector plate configurations to suit different flow and project requirements
- Optional Sight Glass & Manhole
Enables easy inspection, monitoring, and maintenance.
- Optimized Lateral System
Engineered laterals ensure uniform water distribution and high filtration efficiency
- UV-Resistant Fiberglass Construction
Filament-wound, UV-stabilized tank with excellent strength and chemical resistance
- Automatic Air Release
Built-in air release valve and internal vent piping remove trapped air during start-up
- High-Efficiency Filter Nozzles
Consistent flow during filtration and backwashing maximizing filter bed performance while reducing backwash water use by up to 25%



WORKING CONDITIONS	
▲ Maximum Working:	250Kpa/36psi(2.5bar) 400Kpa/58psi(4.0bar)
▲ Testing Pressure:	400Kpa/58psi(4.0bar) 600Kpa/87psi(6.0bar)
▲ Maximum Temperature:	122F (50°C)
▲ Filtration Media:	1mm ~ 2mm(Gravel) 0.5mm ~ 0.8mm(Sand)

Ordering Information

Product	Model	Filter Diameter Inch (mm)	Filter Height Inch (mm)	Flow Rate Gpm/Ft ² (m ³ /h/m ²)	Port Size		Design Flow GPM (m ³ /h)	Filter Area Sq. Ft. (m ²)	Sand Weight 0.5-0.8mm Lbs (Kg)	Gravel Weight 1.0-2.0mm Lbs (Kg)
					De(mm)	Inch				
02010301	FM48	48" (1200)	55.9" (1420)	12.3 (30)	90	3"	150 (34)	12.16 (1.13)	1653 (750)	661 (300)
				16.4 (40)	90	3"	198 (45)			
				20.5 (50)	110	4"	251 (57)			
02010302	FM56	56" (1400)	65.7" (1670)	12.3 (30)	90	3"	203 (46)	16.58 (1.54)	2645 (1200)	1102 (500)
				16.4 (40)	110	4"	269 (61)			
				20.5 (50)	110	4"	339 (77)			
02010303	FM64	64" (1600)	68.9" (1750)	12.3 (30)	110	4"	264 (60)	21.64 (2.01)	4078 (1850)	1653 (750)
				16.4 (40)	160	6"	352 (80)			
				20.5 (50)	160	6"	445 (101)			
02010304	FM72	72" (1800)	76.8" (1950)	12.3 (31)	110	4"	335 (76)	27.34 (2.54)	5511 (2500)	2314 (1050)
				16.4 (41)	160	6"	445 (101)			
				20.5 (51)	160	6"	559 (127)			
02010305	FM80	80" (2000)	83.9" (2130)	12.3 (31)	160	6"	414 (94)	33.80 (3.14)	7275 (3300)	2535 (1150)
				16.4 (41)	160	6"	550 (125)			
				20.5 (51)	160	6"	691 (157)			
02010306	FM88	88" (2200)	92.6" (2350)	12.3 (31)	160	6"	502 (114)	40.90 (3.80)	9149 (4150)	3240 (1470)
				16.4 (41)	160	6"	669 (152)			
				20.5 (51)	200	8"	837 (190)			
02010307	FM92	92" (2300)	92.6" (2350)	12.3 (32)	160	6"	550 (125)	44.67 (4.15)	10802 (4900)	3527 (1600)
				16.4 (42)	200	8"	731 (166)			
				20.5 (52)	200	8"	916 (208)			
02010308	FM94	94" (2350)	92.6" (2350)	12.3 (32)	160	6"	572 (130)	46.72 (4.34)	11023 (5000)	3968 (1800)
				16.4 (42)	200	8"	771 (175)			
				20.5 (52)	200	8"	955 (217)			
02010309	FM100	100" (2500)	96.5" (2450)	12.3 (32)	160	6"	647 (147)	52.74 (4.90)	13227 (6000)	4850 (2200)
				16.4 (42)	200	8"	863 (196)			
				20.5 (52)	200	8"	1079 (245)			
02010310	FM120	120" (3000)	104.3" (2650)	12.3 (33)	200	8"	933 (212)	76.10 (7.07)	18959 (8600)	7275 (3300)
				16.4 (43)	200	8"	1242 (282)			
				20.5 (53)	200	10"	1559 (354)			

FLOWMASTER SERIES

LARGE-DIAMETER, HIGH-FLOW FILTER TANKS FOR COMMERCIAL POOLS VALVE

Dimensions

Model	ØD (mm)	H (mm)	A (mm)	B (mm)	C (mm)	E (mm)	F (mm)	K (mm)	L2 (mm)	M (mm)	N (mm)	L2 (mm)	M (mm)
FM48	1200	1420	560	180	340	60	740	180*180	1150	80	1010	600	300
FM56	1400	1670	650	190	350	60	800	300*400	1250	80	1240	700	300
FM64	1600	1750	680	215	450	60	870	300*400	1450	80	1450	800	320
FM72	1800	1950	730	215	550	60	910	300*400	1650	80	1610	850	320
FM80	2000	2130	800	240	550	60	930	300*400	1700	80	1800	900	350
FM88	2200	2350	900	240	600	60	1070	300*400	1750	80	1800	1000	400
FM92	2300	2350	940	240	600	60	940	300*400	1800	80	2010	1000	400
FM94	2350	2350	940	240	600	60	1070	300*400	1800	80	2010	1000	400
FM100	2500	2450	960	240	600	60	1100	300*400	1900	80	2010	1050	400
FM120	3000	2650	1020	350	600	60	1130	300*400	2150	80	2650	1100	450

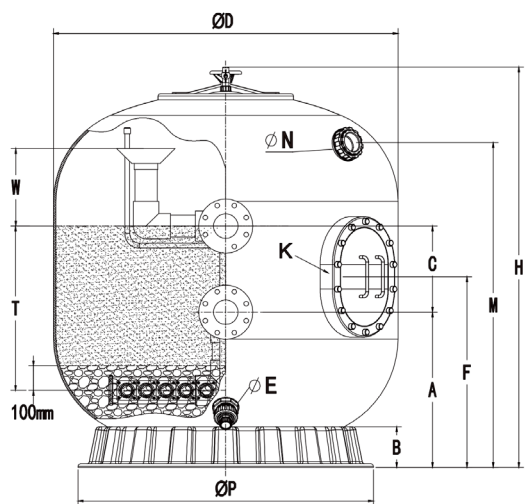

Manhole



Sight Glass



Cover Lid



Pressure Control Manometer Panel



Lateral System

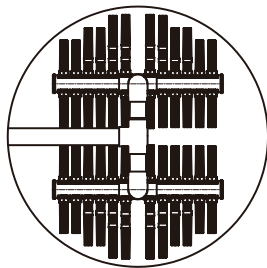

AQUATITAN HORIZONTAL FRP FILTER SERIES

ENGINEERED FOR LARGE-SCALE AQUATIC SYSTEMS VALVE



WORKING CONDITIONS	
▲	Maximum Working: 250Kpa/36psi(2.5bar) 400Kpa/58psi(4.0bar)
▲	Testing Pressure: 400Kpa/58psi(4.0bar) 600Kpa/87psi(6.0bar)
▲	Maximum Temperature: 122F (50°C)
▲	Filtration Media: 1mm ~ 2mm(Gravel) 0.5mm ~ 0.8mm(Sand)

Featured Highlights

- **Advanced Multi-Layer FRP Construction**
Multi-layer anti-corrosion and chemical-resistant inner liner combined with CNC filament-wound fiberglass shell finished with a UV-resistant exterior coating for long-term durability
- **Optimized Internal Piping Design**
Uniform and well-engineered internal piping system ensures balanced flow distribution and efficient filtration performance
- **Heavy-Duty Fiberglass Support Base**
Robust FRP base provides strong structural support and reliable load-bearing capacity for the tank
- **Factory Pressure Tested for Reliability**
Each unit is rigorously pressure-tested before delivery to ensure safe and stable operation
- **High Performance with Excellent Value**
Engineered for premium filtration performance while offering outstanding cost-effectiveness
- **Stackable Horizontal Design**
Space-saving stackable configuration minimizes footprint and improves equipment room efficiency

AQUATITAN HORIZONTAL FRP FILTER SERIES

ENGINEERED FOR LARGE-SCALE AQUATIC SYSTEMS VALVE

Ordering Information

Product	Model	Filter Diameter Inch (mm)	Filter Height Inch (mm)	Flow Rate		Port Size		Design Flow GPM (m ³ /h)	Filter Area Sq. Ft. (m ²)	Sand Weight 0.5-0.8mm Lbs (Kg)	Gravel Weight 1.0-2.0mm Lbs (Kg)
				Gpm/Ft ²	(m ³ /h/m ²)	De(mm)	Inch				
02010401	AT1219	48" (1200)	24.72 (1390)	8.2 (20)	90	3"	149.6 (34)	12.16 (1.13)	1650 (750)	660 (300)	
				12.3 (30)	110	3"	198 (45)				
				16.4 (40)	160	4"	250.8 (57)				
02010402	AT1223	48" (1200)	24.72 (1390)	8.2 (20)	110	3"	202.4 (46)	16.57 (1.54)	2645 (1200)	1100 (500)	
				12.3 (30)	160	4"	268.4 (61)				
				16.4 (40)	160	4"	338.8 (77)				
02010403	AT1225	48" (1200)	24.72 (1390)	8.2 (20)	110	4"	264 (60)	21.62 (2.01)	4070 (1850)	1650 (750)	
				12.3 (30)	160	6"	352 (80)				
				16.4 (40)	160	6"	444.4 (101)				
02010404	AT1227	48" (1200)	24.72 (1390)	8.2 (20)	110	4"	334.4 (76)	27.33 (2.54)	5500 (2500)	2310 (1050)	
				12.3 (30)	160	6"	444.4 (101)				
				16.4 (40)	160	6"	558.8 (127)				
02010405	AT1230	48" (1200)	24.72 (1390)	8.2 (20)	110	6"	413.6 (94)	33.79 (3.14)	7260 (3300)	2530 (1150)	
				12.3 (30)	160	6"	550 (125)				
				16.4 (40)	160	6"	690.8 (157)				

Dimensions

Model	ØD (mm)	H (mm)	A (mm)	B (mm)	C (mm)	K (mm)	P (mm)	L (mm)	L2 (mm)	T (mm)	W (mm)
AT1219	1200	1390	725	250	340	80	900	1900	2050	550	225
AT1223	1200	1390	725	250	340	80	900	2300	2450	550	225
AT1225	1200	1390	725	250	340	80	900	2500	2650	550	225
AT1227	1200	1390	725	250	340	80	900	2700	2850	550	225
AT1230	1200	1390	725	250	340	80	900	3000	3150	550	225

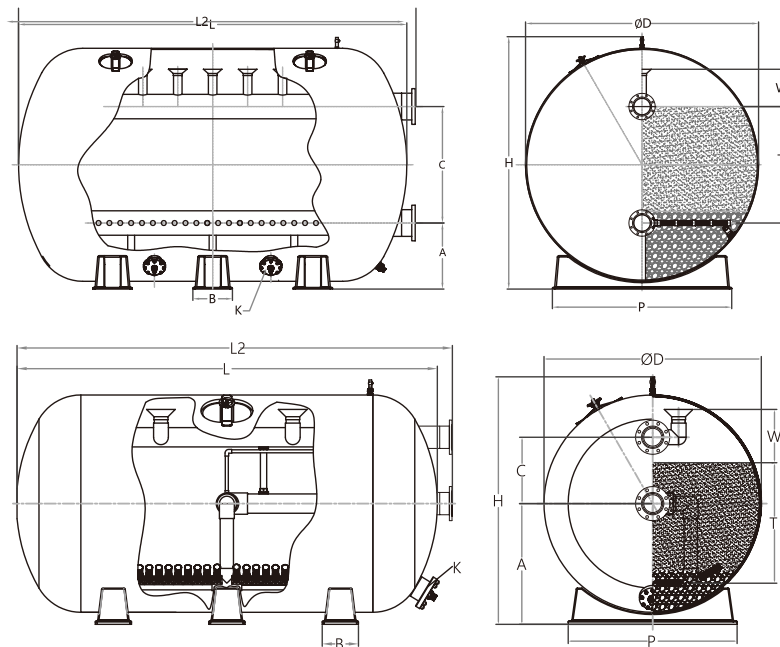

AQUATITAN HORIZONTAL FRP FILTER SERIES

ENGINEERED FOR LARGE-SCALE AQUATIC SYSTEMS

Ordering Information

Product	Model	Filter Diameter Inch (mm)	Filter Height Inch (mm)	Flow Rate Gpm/Ft ² (m ³ /h/m ²)	Port Size		Design Flow GPM (m ³ /h)	Filter Area Sq. Ft. (m ²)	Sand Weight 0.5-0.8mm Lbs (Kg)	Gravel Weight 1.0-2.0mm Lbs (Kg)
					De(mm)	Inch				
02010406	AT1419	55.12 (1400)	63 (1600)	8.2 (20)	110	4"	198 (45)	23.99 (2.23)	4400 (2000)	1276 (580)
				12.3 (30)	110	4"	294.8 (67)			
				16.4 (40)	160	6"	391.6 (89)			
02010407	AT1425	55.12 (1400)	63 (1600)	8.2 (20)	110	4"	264 (60)	32.49 (3.02)	6050 (2750)	1760 (800)
				12.3 (30)	160	6"	400.4 (91)			
				16.4 (40)	160	6"	532.4 (121)			
02010408	AT1430	55.12 (1400)	63 (1600)	8.2 (20)	160	6"	321.2 (73)	39.49 (3.67)	7425 (3375)	2200 (1000)
				12.3 (30)	160	6"	484 (110)			
				16.4 (40)	160	6"	646.8 (147)			

Dimensions

Model	ØD (mm)	H (mm)	A (mm)	B (mm)	C (mm)	K (mm)	P (mm)	L (mm)	L2 (mm)	T (mm)	W (mm)
AT1419	1400	1600	810	300	400	110	960	1900	2050	750	225
AT1425	1400	1600	810	300	400	110	960	2450	2450	750	225
AT1430	1400	1600	810	300	400	110	960	3150	3150	750	225

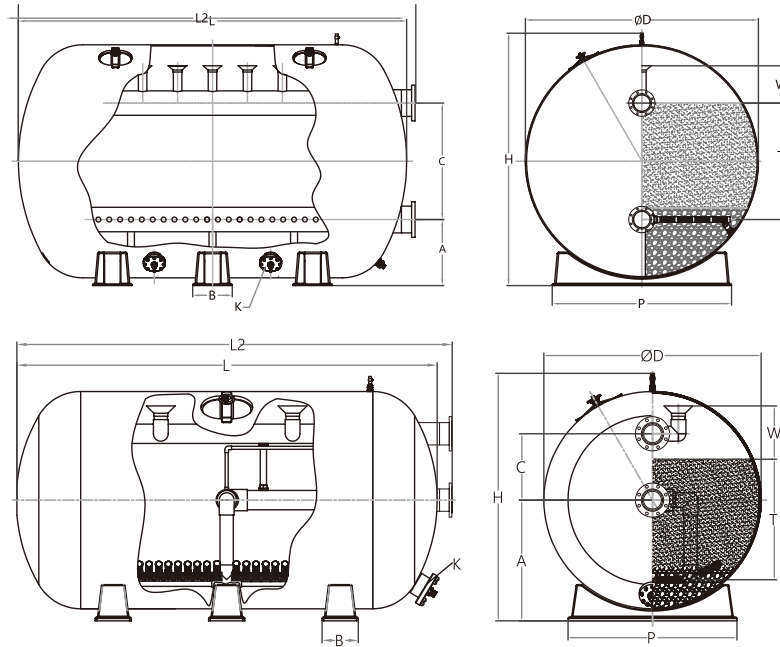

HYDRO PURE FILTER SERIES

FOR SPAS, HOT TUBS AND SWIMMING POOLS



WORKING CONDITIONS

- ▲ Maximum Operating Pressure: 350 kPa / 50.8 psi (3.5 bar)
- ▲ Maximum Temperature: 40°C (104°F)

Featured Highlights

- High-density fiber cartridge for efficient filtration
- UV-resistant, fully sealed housing
- Equipped with 50 mm and 63 mm unions
- Tool-free design for easy installation and removal
- Integrated pressure-relief safety device
- Automatic air-release valve for quick venting
- Suitable for swimming pools, spas freshwater and seawater

Ordering Information

Product	Model	Filter Area Sq. ft. (m ²)	Flow Rated Gpm (m ³ /h)	Port Size	Filter Dimensions		Carton Wt. (Lbs.)
					Height Inch (mm)	Diameter In (mm)	
02020101	HP25	24.76 (2.3)	30.82 (7.0)	1.5" & 2.0"	15.24 (387)	8.86 (225)	12.9 (5.85)
02020102	HP50	50.59 (4.7)	61.64 (14.0)	1.5" & 2.0"	22.32 (567)	8.86 (225)	16.2 (7.35)
02020103	HP75	75.35 (7.0)	74.85 (17.0)	1.5" & 2.0"	29.41 (747)	8.86 (225)	19.95 (9.05)
02020104	HP100	101.18 (9.4)	100.83 (22.9)	1.5" & 2.0"	36.5 (927)	8.86 (225)	23.81 (10.8)
02020105	HP150	150.69 (14.0)	147.06 (33.4)	1.5" & 2.0"	43.58 (1107)	8.86 (225)	27.78 (12.6)

Ordering Information

Product	Model	Filter Area Sq. ft. (m ²)	Flow Rated Gpm (m ³ /h)
02020111	HP25-RC	24.76 (2.3)	30.82 (7.0)
02020111	HP50-RC	50.59 (4.7)	61.64 (14.0)
02020111	HP75-RC	75.35 (7.0)	74.85 (17.0)
02020111	HP100-RC	101.18 (9.4)	100.83 (22.9)
02020111	HP150-RC	150.69 (14.0)	147.06 (33.4)

HP Cartridge Filter

Technical Parameters		
Model	Pump Range (w)	Max. Pressure (Kpa)
HP25	250-370	350
HP50	550-750	350
HP75	750-1500	350
HP100	1100-1500	350
HP150	1100-2200	350

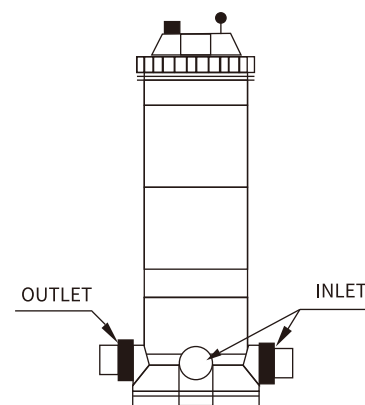

More cartridge elements for various brands available—contact us.

HYDROMAX PRO DE FILTER SERIES

HIGH-CAPACITY FILTRATION ENGINEERED FOR MAXIMUM PERFORMANCE

Featured Highlights

- High-Capacity DE Filtration**
 Engineered for superior performance in commercial and large residential pools
- Efficient Up-Flow Desig**
 Up-flow filtration with top-down backwashing for maximum efficiency
- Heavy-Duty Grid Construction**
 High-impact grid elements ensure durability and long service life
- Quick-Release Air Relief Valve**
 Manual air relief with a fast quarter-turn operation
- Easy Service Access**
 Self-aligned tank top and bottom simplify grid maintenance
- All-Weather Reliability**
 Built for dependable operation in all climates



WORKING CONDITIONS

- ⚠ Maximum Operating Pressure: 350 kPa / 50.8 psi (3.5 bar)
- ⚠ Maximum Temperature: 40°C (104°F)

Ordering Information

Product	Model	Effective Filtration Area Ft ² (m ³)	Flow Rated GPM (m ³ /h)	Plumbing Inch	Amount of Diatomaceous Earth LBS(KGS.)
02030101	HM01	48 (4.46)	96 (21.80)	2"	6.0 (2.72)
02030102	HM02	62 (5.76)	120 (27.25)	2"	7.7 (3.49)

Element Grid Set for D.E. Filter

Product	Model	ADAPTIVE D.E. FILTER	DESIGN FLOW RATE Gpm (m ³ /h)	CARTON DIMENSION (CM)	NET WEIGHT Lbs (Kg)
02030111	HE01	02030101	96 (21.80)	47 x 39 x 66	14.99 (6.8)
02030112	HE02	02030102	120 (27.25)	47 x 39 x 84	19.18 (8.7)

HYDROMAX PRO DE FILTER SERIES

HIGH-CAPACITY FILTRATION ENGINEERED FOR MAXIMUM PERFORMANCE

Dimensions

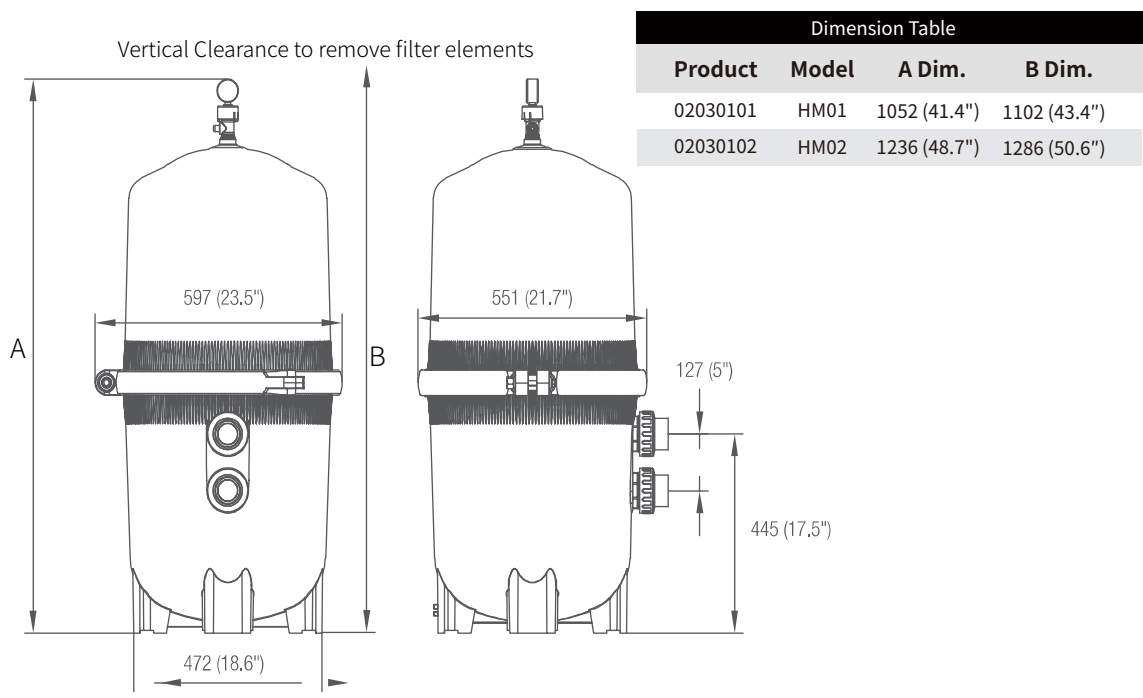

More DE replacement models are available—contact us.

 WATERWAVE

REGENERATIVE MEDIA FILTRATION SYSTEM



WHY REGENERATIVE FILTRATION IS BECOMING THE NEW STANDARD

With increasing demands for superior water quality, sustainability, and operational efficiency, regenerative media filtration is rapidly becoming the preferred solution in high-end aquatic facilities.

Using perlite as the filtration medium, this advanced technology delivers ultra-fine filtration performance, significantly outperforming conventional sand filtration systems.



Waterwave Regenerative Media Filters are ideal for:



Competition & Olympic swimming pools



Luxury hotels & resorts



Water parks & aquatic centers



Private clubs & wellness facilities



High-end residential pools

What is Perlite?



Perlite is a natural volcanic mineral expanded under high temperature. It forms a highly porous structure, allowing it to trap particles as small as 1–5 microns, ensuring exceptional water clarity

Waterwave Regenerative Media Filter Series is designed to meet the highest standards of modern pool water treatment, combining performance, efficiency and reliability

ENGINEERED FOR PERFORMANCE AND RELIABILITY

System Schematic Diagram

The Waterwave Regenerative Media Filter operates by coating a layer of perlite onto the filter septa. As water passes through, fine particles are trapped efficiently, delivering superior filtration results. When the pressure increases, the system performs regeneration instead of traditional backwashing, significantly reducing water loss.

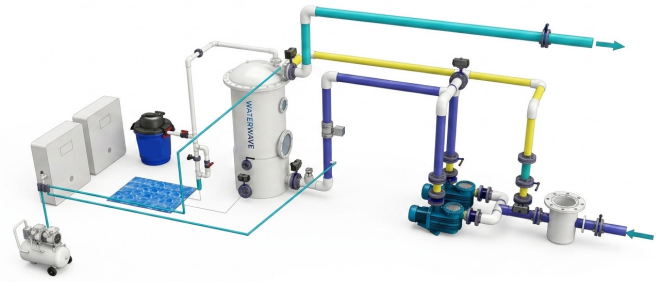

Technical Data

Compact Series							
Code	Model	Filtration Area (m ²)	Design Flow Rate (m ³ /h)	Tank Diameter (mm)	Tank Height (mm)	Media Consumption (kg)	Suggested Electrical Load (kW)
02040101	WW-RPF-C34	10.0	34.0	600.0	1.5-1.7	3.9	7.2
02040102	WW-RPF-C53	15.8	53.7	720.0	1.5-1.7	6.1	9.0
02040103	WW-RPF-C64	18.9	64.3	810.0	1.5-1.7	7.3	10.5
02040104	WW-RPF-C97	28.8	97.9	900.0	1.5-1.7	11.1	12.5
02040105	WW-RPF-C141	41.5	141.1	1110.0	1.5-1.7	16.0	16.0

Efficiency Series							
Code	Model	Filtration Area (m ²)	Design Flow Rate (m ³ /h)	Tank Diameter (mm)	Tank Height (mm)	Media Consumption (kg)	Electrical Load (kW)
02040201	WW-RPF-E69	20.5	69.7	600.0	1.9-2.1	7.9	10.5
02040202	WW-RPF-E84	24.8	84.3	720.0	1.9-2.1	9.6	12.5
02040203	WW-RPF-E101	29.7	101.0	810.0	1.9-2.1	11.5	12.5
02040204	WW-RPF-E154	45.3	154.0	900.0	1.9-2.1	17.5	16.0
02040205	WW-RPF-E170	50.0	170.0	1110.0	1.9-2.1	19.3	20.0

Performance Series							
Code	Model	Filtration Area (m ²)	Design Flow Rate (m ³ /h)	Tank Diameter (mm)	Tank Height (mm)	Media Consumption (kg)	Electrical Load (kW)
02040301	WW-RPF-P103	30.5	103.7	720.0	2.2-2.5	11.8	12.5
02040302	WW-RPF-P124	36.5	124.1	810.0	2.2-2.5	14.1	14.0
02040303	WW-RPF-P189	55.6	189.0	900.0	2.2-2.5	21.5	20.0
02040304	WW-RPF-P243	71.6	243.4	1000.0	2.2-2.5	27.6	27.0
02040305	WW-RPF-P272	80.0	272.0	1110.0	2.2-2.5	30.9	27.0
02040306	WW-RPF-P332	97.8	332.5	1200.0	2.2-2.5	37.7	27.0
02040307	WW-RPF-P403	118.6	403.2	1300.0	2.2-2.5	45.8	35.0
02040308	WW-RPF-P559	164.6	559.6	1500.0	2.2-2.5	63.5	50.0

Final data to be confirmed based on actual product specifications

THE FUTURE OF FILTRATION: REGENERATIVE MEDIA VS TRADITIONAL SAND

Superior Clarity. Minimal Footprint. Maximum Sustainability.



Commercial Training & Competition Pool (50 × 21 × 2 m = 2,100 m³)
4-hour turnover filtration cycle | Required flow rate: 525 m³/h

Filtration System Comparison

	WATERWAVE RMF	Sand Filter
System Configuration	2 × WW-RPF-P272 (272 m ³ /h/unit)	7 × Ø2000 mm (78 m ³ /h/unit)
Material	SS316 Stainless Steel	FRP (Fiber Wound)
Design Filtration Rate	3.4 m ³ /m ² /h	25 m ³ /m ² /h
Pump Power Consumption	30 kW	52 kW
Plant Room Area Required	20m ²	100m ²
Backwash Water Consumption	2.53 tons	42 tons
Filtration Accuracy	1 μm	20-50 μm
Chemical Consumption	Low	High
Water Turbidity	0.1 NTU	1.0 NTU
Pool Visibility	Upto 50m	<25m

Operation & Maintenance

WATERWAVE RMF	VS	Sand Filter
One-touch smart control		Manual or semi-automatic operation
Remote monitoring & control		Labor-intensive maintenance
Centralized system management		Limited automation capability
Multi-device integration		
IoT-based smart automation		

FROM DESIGN TO DELIVERY ONE PARTNER ONE RESPONSIBILITY

Waterwave provides a complete solution, ensuring seamless project execution from concept to operation

Workflow



Consultation & Requirement Analysis

Understanding project needs and local standards



System Design & Selection

Customized filtration solution based on pool type



Engineering Support

Technical drawings, layout, and integration support



Manufacturing & Quality Control

Strict production standards and inspection



Installation Guidance

On-site or remote technical assistance



Commissioning & Testing

System optimization and performance verification



After-Sales Service

Continuous technical support and maintenance guidance

Delivering crystal-clear water, operational efficiency, and long-term value for every project

WATERWAVE

LIGHTS

- ◆ LUMIWAVE COLOR LED LIGHTS
- ◆ LUMIBRITE PRO SERIES

LUMIWAVE COLOR LED LIGHTS

UNDERWATER LED LIGHTS FOR SWIMMING POOLS AND SPAS

Featured Highlights

- **Universal Nozzle Fit:** Compatible with the industry's most common nozzle sizes: 2" (1.5" internal) and 2.5" (2" internal) threads
- **Works in Any Pool:** A versatile design suitable for every pool structure and installation environment
- **Made to Last:** Premium materials and reinforced sealing deliver exceptional durability, reliability, and long-lasting performance



Ordering Information

Product	Model	Voltage	Wattage	Color	Material
03010101	LW0101	12V AC/DC	8W	Warm White / Cool White /Blue/ RGB/ RGBW	Anti-UV Plastic Fully Resin Filled
03010102	LW0102	12V AC/DC	12W	Warm White / Cool White /Blue/ RGB/ RGBW	Anti-UV Plastic Fully Resin Filled

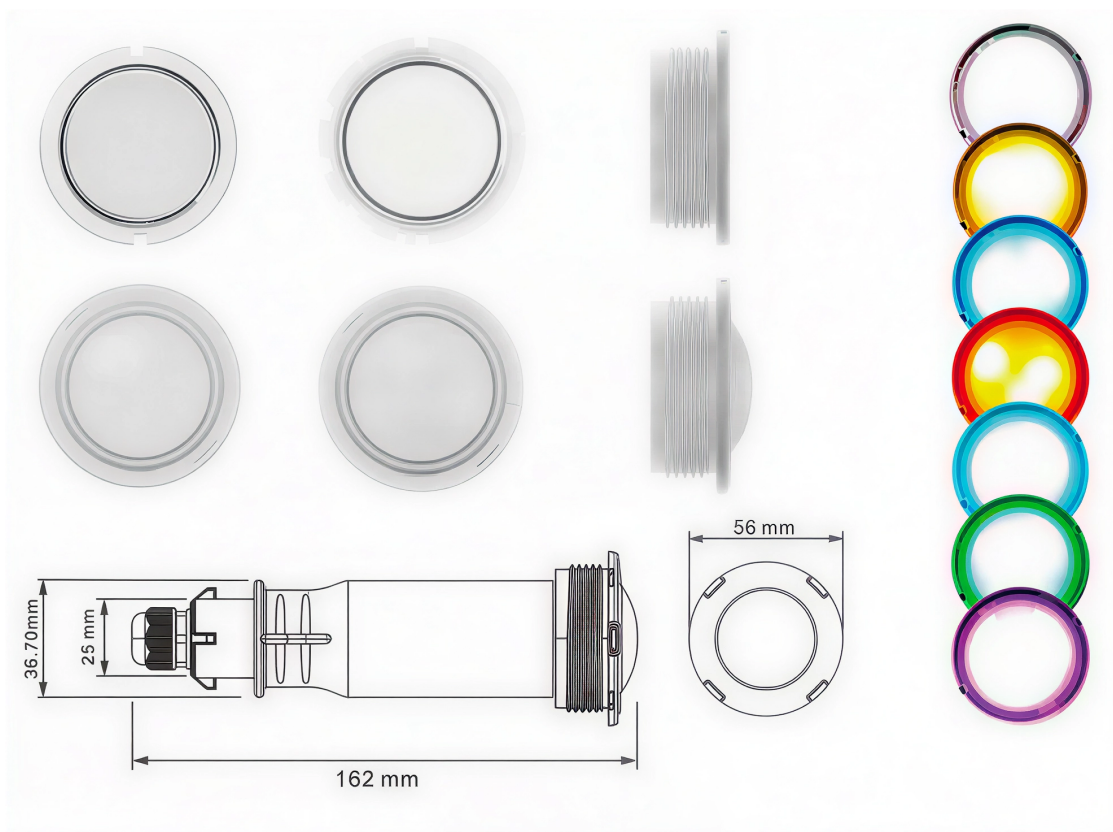

LUMIWAVE COLOR LED LIGHTS

UNDERWATER LED LIGHTS FOR SWIMMING POOLS AND SPAS



Featured Highlights

- **Universal Nozzle Fit:** Compatible with the industry's most common nozzle sizes: 2" (1.5" internal) and 2.5" (2" internal) threads
- **Works in Any Pool:** A versatile design suitable for every pool structure and installation environment
- **Made to Last:** Premium materials and reinforced sealing deliver exceptional durability, reliability, and long-lasting performance.

Ordering Information

Product	Model	Voltage	Wattage	Color	Material
03020101	LW0201	12V AC/DC	30W	Warm White / Cool White /Blue/ RGB/ RGBW	316L Stainless Steel

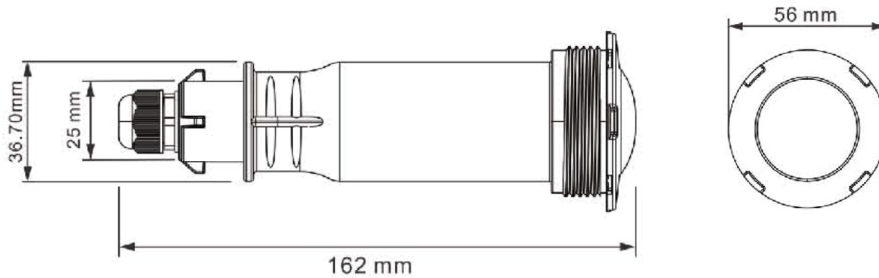

LUMIWAVE COLOR LED LIGHTS

UNDERWATER LED LIGHTS FOR SWIMMING POOLS AND SPAS

Featured Highlights

- **Universal Nozzle Fit:** Compatible with the industry's most common nozzle sizes: 2" (1.5" internal) and 2.5" (2" internal) threads
- **Works in Any Pool:** A versatile design suitable for every pool structure and installation environment
- **Made to Last:** Premium materials and reinforced sealing deliver exceptional durability, reliability, and long-lasting performance.



Ordering Information

Product	Model	Voltage	Wattage	Color	Material
03020102	LW0202	12V AC/DC	6W	Warm White / Cool White /Blue/ RGB/ RGBW	316L Stainless Steel

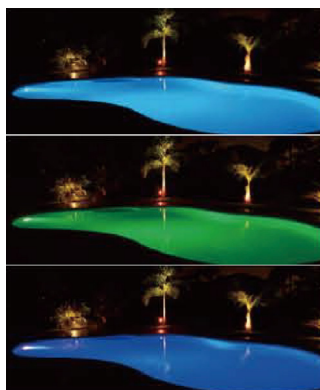
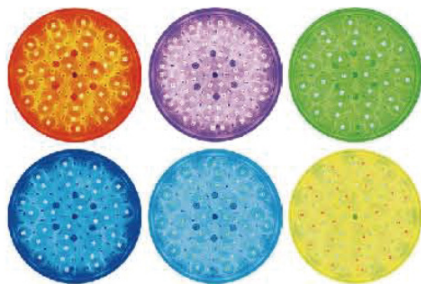

LUMIWAVE COLOR LED LIGHTS

UNDERWATER LED LIGHTS FOR SWIMMING POOLS AND SPAS



Featured Highlights

- Multi-Application Design: Suitable for swimming pools, fountains, and ponds
- UV-Resistant Housing: Anti-UV materials prevent yellowing and degradation
- Fully Resin-Filled Structure: Ensures excellent waterproofing and long-term reliability
- Surface-Mounted Installation: Easy to install without niche construction
- High Durability & Safety Stable performance under long-term underwater use

Ordering Information

Product	Model	Voltage	Wattage	Color	Material
03030101	LW0301	12V AC/DC	6W	Warm White / Cool White /Blue/ RGB/ RGBW	Anti-UV Plastic Fully Resin Filled
03030102	LW0302	12V AC/DC	10W	Warm White / Cool White /Blue/ RGB/ RGBW	Anti-UV Plastic Fully Resin Filled



LUMIWAVE COLOR LED LIGHTS

UNDERWATER LED LIGHTS FOR SWIMMING POOLS AND SPAS

Featured Highlights

- Multi-Application Design: Suitable for swimming pools, fountains and ponds
- UV-Resistant Housing: Anti-UV materials prevent yellowing and degradation
- Fully Resin-Filled Structure: Ensures excellent waterproofing and long-term reliability
- Surface-Mounted Installation: Easy to install without niche construction
- High Durability & Safety Stable performance under long-term underwater use



Ordering Information

Product	Model	Voltage	Wattage	Color	Material
03030103	LW0303	12V AC/DC	10W	Warm White / Cool White /Blue/ RGB/ RGBW	Anti-UV Plastic Fully Resin Filled
03030104	LW0304	12V AC/DC	18W	Warm White / Cool White /Blue/ RGB/ RGBW	Anti-UV Plastic Fully Resin Filled

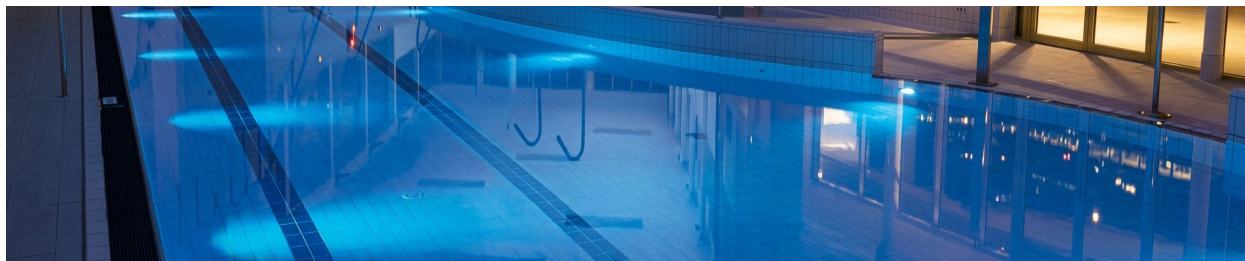

LUMIWAVE COLOR LED LIGHTS

UNDERWATER LED LIGHTS FOR SWIMMING POOLS AND SPAS

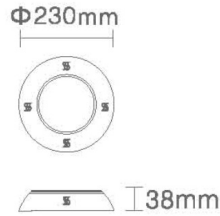

Featured Highlights

- Multi-Application Design: Suitable for swimming pools, fountains and ponds
- UV-Resistant Housing: Anti-UV materials prevent yellowing and degradation
- Fully Resin-Filled Structure: Ensures excellent waterproofing and long-term reliability
- Surface-Mounted Installation: Easy to install without niche construction
- High Durability & Safety Stable performance under long-term underwater use

Ordering Information

Product	Model	Voltage	Wattage	Color	Material
03030105	LW0305	12V AC/DC	18W	Warm White / Cool White /Blue/ RGB/ RGBW	Anti-UV Plastic Fully Resin Filled
03030106	LW0306	12V AC/DC	24W	Warm White / Cool White /Blue/ RGB/ RGBW	Anti-UV Plastic Fully Resin Filled
03030107	LW0307	12V AC/DC	35W	Warm White / Cool White /Blue/ RGB/ RGBW	Anti-UV Plastic Fully Resin Filled
03030108	LW0308	12V AC/DC	42W	Warm White / Cool White /Blue/ RGB/ RGBW	Anti-UV Plastic Fully Resin Filled

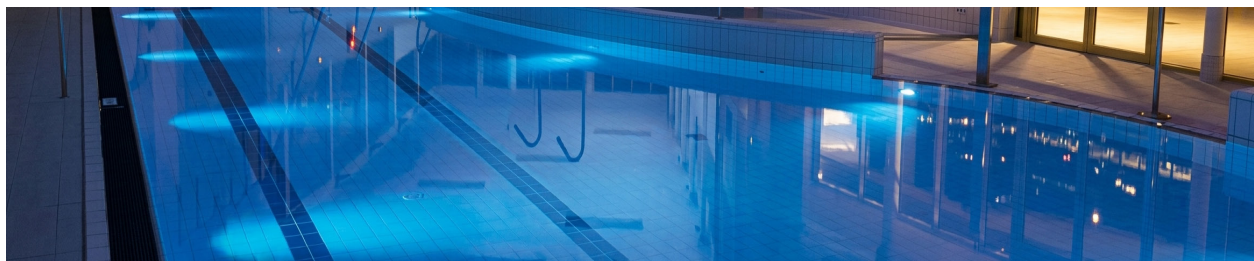

LUMIWAVE COLOR LED LIGHTS

UNDERWATER LED LIGHTS FOR SWIMMING POOLS AND SPAS

Featured Highlights

- Multi-Application Design: Suitable for swimming pools, fountains and ponds
- UV-Resistant Housing: Anti-UV materials prevent yellowing and degradation
- Fully Resin-Filled Structure: Ensures excellent waterproofing and long-term reliability
- Surface-Mounted Installation: Easy to install without niche construction
- High Durability & Safety Stable performance under long-term underwater use



Ordering Information

Product	Model	Voltage	Wattage	Color	Material
03030109	LW0309	12V AC/DC	10W	Warm White / Cool White /Blue/ RGB/ RGBW	Anti-UV Plastic Fully Resin Filled
03030110	LW0310	12V AC/DC	18W	Warm White / Cool White /Blue/ RGB/ RGBW	Anti-UV Plastic Fully Resin Filled
03030111	LW0311	12V AC/DC	10W	Warm White / Cool White /Blue/ RGB/ RGBW	Anti-UV Plastic Fully Resin Filled
03030112	LW0312	12V AC/DC	18W	Warm White / Cool White /Blue/ RGB/ RGBW	Anti-UV Plastic Fully Resin Filled



LUMIWAVE COLOR LED LIGHTS

UNDERWATER LED LIGHTS FOR SWIMMING POOLS AND SPAS

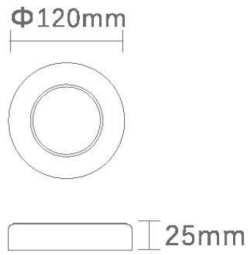

Featured Highlights

- 316L Stainless Steel: Corrosion-resistant and durable
- Fully Resin-Filled: Waterproof and reliable
- Surface-Mounted: Easy installation, no niche required
- Multi-Use: Suitable for pools, fountains and ponds

Ordering Information

Product	Model	Voltage	Wattage	Color	Material
03040101	LW0401	12V AC/DC	6W	Warm White / Cool White /Blue/ RGB/ RGBW	316L Stainless Steel Fully Resin Filled
03040102	LW0402	12V AC/DC	10W	Warm White / Cool White /Blue/ RGB/ RGBW	316L Stainless Steel Fully Resin Filled



LUMIWAVE COLOR LED LIGHTS

UNDERWATER LED LIGHTS FOR SWIMMING POOLS AND SPAS

Featured Highlights

- 316L Stainless Steel: Corrosion-resistant and durable
- Fully Resin-Filled: Waterproof and reliable
- Surface-Mounted: Easy installation, no niche required
- Multi-Use: Suitable for pools, fountains and ponds



Φ210mm



±28mm

Ordering Information

Product	Model	Voltage	Wattage	Color	Material
03040103	LW0403	12V AC/DC	10W	Warm White / Cool White /Blue/ RGB/ RGBW	Anti-UV Plastic Fully Resin Filled
03040104	LW0404	12V AC/DC	18W	Warm White / Cool White /Blue/ RGB/ RGBW	Anti-UV Plastic Fully Resin Filled

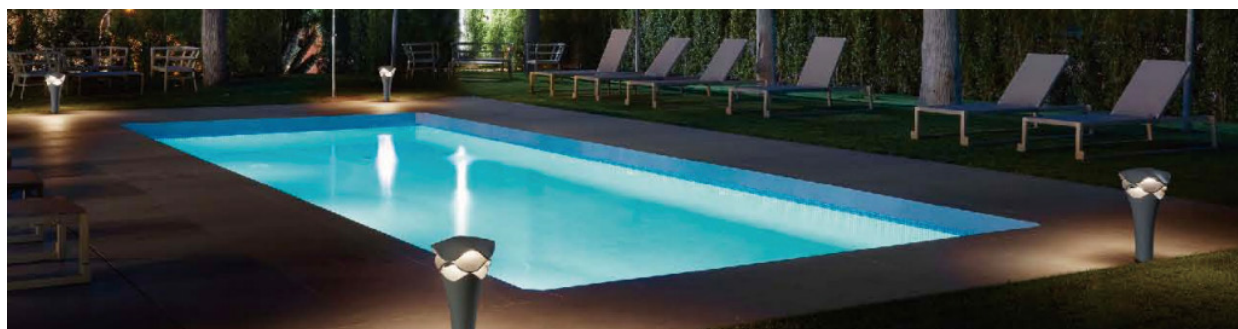

LUMIWAVE COLOR LED LIGHTS

UNDERWATER LED LIGHTS FOR SWIMMING POOLS AND SPAS



Featured Highlights

- 316L Stainless Steel: Corrosion-resistant and durable
- Fully Resin-Filled: Waterproof and reliable
- Surface-Mounted: Easy installation, no niche required
- Multi-Use: Suitable for pools, fountains and ponds

Ordering Information

Product	Model	Voltage	Wattage	Color	Material
03040105	LW0405	12V AC/DC	18W	Warm White / Cool White /Blue/ RGB/ RGBW	316L Stainless Steel Fully Resin Filled
03040106	LW0406	12V AC/DC	24W	Warm White / Cool White /Blue/ RGB/ RGBW	316L Stainless Steel Fully Resin Filled
03040107	LW0407	12V AC/DC	35W	Warm White / Cool White /Blue/ RGB/ RGBW	316L Stainless Steel Fully Resin Filled
03040108	LW0408	12V AC/DC	24W	Warm White / Cool White /Blue/ RGB/ RGBW	316L Stainless Steel Fully Resin Filled



LUMIWAVE COLOR LED LIGHTS

UNDERWATER LED LIGHTS FOR SWIMMING POOLS AND SPAS

Featured Highlights

- 316L Stainless Steel: Corrosion-resistant and durable
- Fully Resin-Filled: Waterproof and reliable
- Surface-Mounted: Easy installation, no niche required
- Multi-Use: Suitable for pools, fountains, and ponds

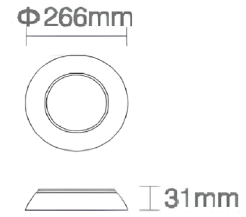

Ordering Information

Product	Model	Voltage	Wattage	Color	Material
03040109	LW0409	12V AC/DC	18W	Warm White / Cool White /Blue/ RGB/ RGBW	316L Stainless Steel Fully Resin Filled
03040110	LW0410	12V AC/DC	24W	Warm White / Cool White /Blue/ RGB/ RGBW	316L Stainless Steel Fully Resin Filled
03040111	LW0411	12V AC/DC	35W	Warm White / Cool White /Blue/ RGB/ RGBW	316L Stainless Steel Fully Resin Filled
03040112	LW0412	12V AC/DC	42W	Warm White / Cool White /Blue/ RGB/ RGBW	316L Stainless Steel Fully Resin Filled

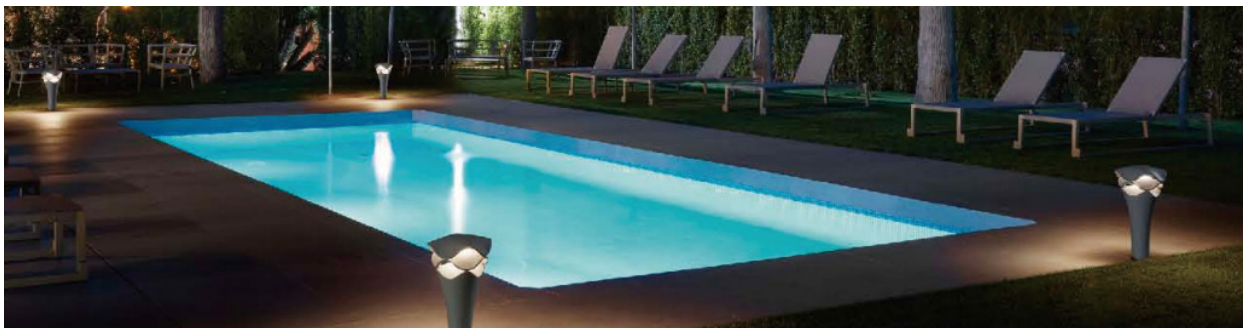

LUMIWAVE COLOR LED LIGHTS

UNDERWATER LED LIGHTS FOR SWIMMING POOLS AND SPAS

Featured Highlights

- 316L Stainless Steel: Corrosion-resistant and durable
- Fully Resin-Filled: Waterproof and reliable
- Multi-Use: Suitable for pools, fountains and ponds



Ordering Information

Product	Model	Voltage	Wattage	Color	Material
03040201	LM0411	12V/24V (AC/DC)	12W	Warm White / White/ Cool White/ RGB	316L Stainless Steel
03040202	LM0412	12V/24V (AC/DC)	18W	Warm White / White/ Cool White/ RGB	316L Stainless Steel

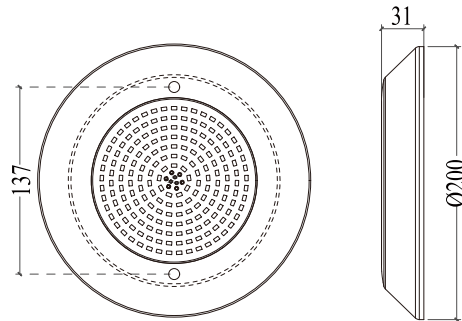

LUMIWAVE COLOR LED LIGHTS

UNDERWATER LED LIGHTS FOR SWIMMING POOLS AND SPAS



Featured Highlights

- 316L Stainless Steel: Corrosion-resistant and durable
- Fully Resin-Filled: Waterproof and reliable
- Multi-Use: Suitable for pools, fountains and ponds

Ordering Information

Product	Model	Voltage	Wattage	Color	Material
03040213	LW0413	12V/24V (AC/DC)	18W	Warm White / White/ Cool White/ RGB	316L Stainless Steel
03040214	LW0414	12V/24V (AC/DC)	25W	Warm White / White/ Cool White/ RGB	316L Stainless Steel
03040215	LW0415	12V/24V (AC/DC)	35W	Warm White / White/ Cool White/ RGB	316L Stainless Steel

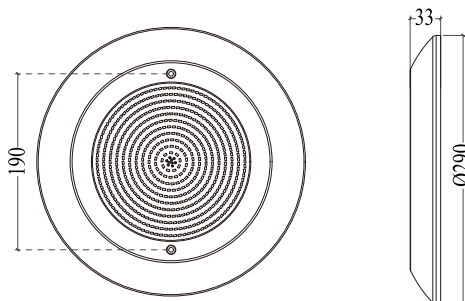

LUMIWAVE COLOR LED LIGHTS

UNDERWATER LED LIGHTS FOR SWIMMING POOLS AND SPAS

Featured Highlights

- 316L Stainless Steel: Corrosion-resistant and durable
- Fully Resin-Filled: Waterproof and reliable
- Multi-Use: Suitable for pools, fountains and ponds



Ordering Information

Product	Model	Voltage	Wattage	Color	Material
03050108	LM0508	12V/24V (AC/DC)	3W	Warm White / White/ Cool White/ RGB	316L Stainless Steel

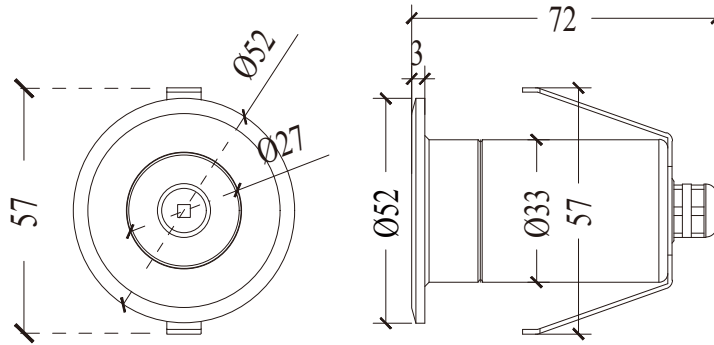

LUMIWAVE COLOR LED LIGHTS

UNDERWATER LED LIGHTS FOR SWIMMING POOLS AND SPAS



Featured Highlights

- 316L Stainless Steel: Corrosion-resistant and durable
- Fully Resin-Filled: Waterproof and reliable
- Multi-Use: Suitable for pools, fountains and ponds

Ordering Information

Product	Model	Voltage	Wattage	Color	Material
03050109	LM0509	12V/24V (AC/DC)	5W	Warm White / White/ Cool White/ RGB	316L Stainless Steel

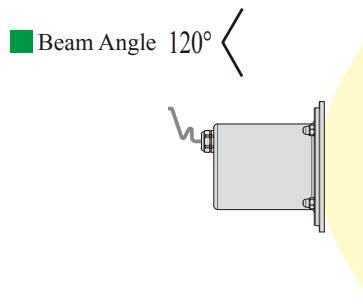
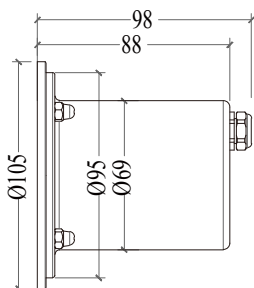
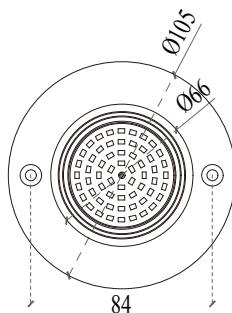

LUMIWAVE COLOR LED LIGHTS

UNDERWATER LED LIGHTS FOR SWIMMING POOLS AND SPAS

Featured Highlights

- 316L Stainless Steel: Corrosion-resistant and durable
- Fully Resin-Filled: Waterproof and reliable
- Multi-Use: Suitable for pools, fountains and ponds



Ordering Information

Product	Model	Voltage	Wattage	Color	Material
03050110	LM0510	12V/24V (AC/DC)	12W	Warm White / White/ Cool White/ RGB/RGBW	316L Stainless Steel
03050111	LM0511	12V/24V (AC/DC)	18W	Warm White / White/ Cool White/ RGB/RGBW	316L Stainless Steel
03050112	LM0512	12V/24V (AC/DC)	30W	Warm White / White/ Cool White/ RGB/RGBW	316L Stainless Steel

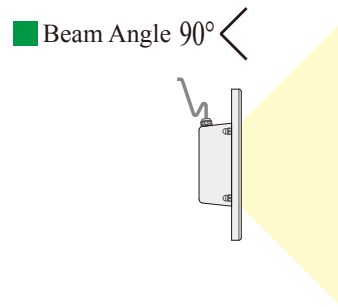
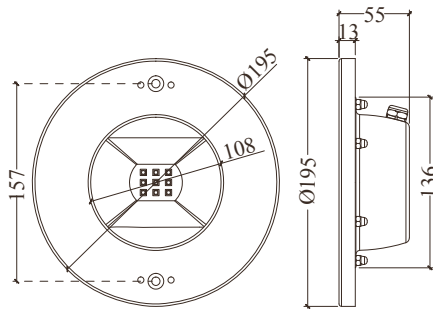

LUMIWAVE COLOR LED LIGHTS

UNDERWATER LED LIGHTS FOR SWIMMING POOLS AND SPAS



Featured Highlights

- 316L Stainless Steel: Corrosion-resistant and durable
- Fully Resin-Filled: Waterproof and reliable
- Multi-Use: Suitable for pools, fountains and ponds

Ordering Information

Product	Model	Voltage	Wattage	Color	Material
03050113	LM0513	12V/24V (AC/DC)	18W	Warm White / White/ Cool White/ RGB/RGBW	316L Stainless Steel
03050114	LM0514	12V/24V (AC/DC)	35W	Warm White / White/ Cool White/ RGB/RGBW	316L Stainless Steel

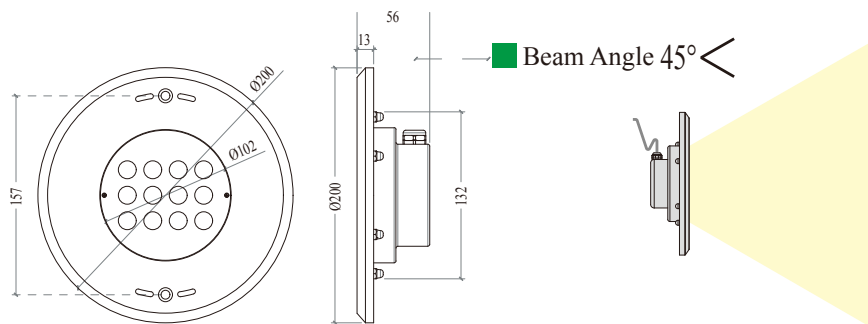

LUMIWAVE COLOR LED LIGHTS

UNDERWATER LED LIGHTS FOR SWIMMING POOLS AND SPAS

Featured Highlights

- 316L Stainless Steel: Corrosion-resistant and durable
- Fully Resin-Filled: Waterproof and reliable
- Multi-Use: Suitable for pools, fountains and ponds

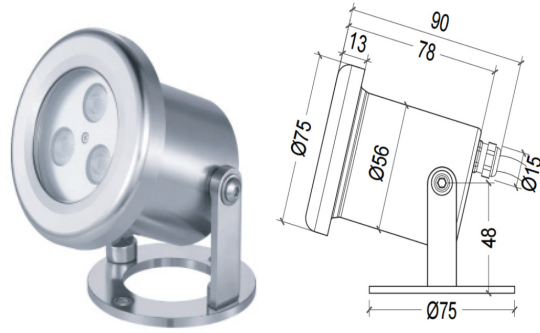

Ordering Information

Product	Model	Voltage	Wattage	Color	Material
03060101	LM0601	12V (AC/DC)	6W	Warm White / White/ Cool White/ RGB/RGBW	316L Stainless Steel
03060102	LM0602	12V (AC/DC)	12W	Warm White / White/ Cool White/ RGB/RGBW	316L Stainless Steel

LUMIBRITE PRO SERIES

LUXURY LIGHTING FOR YOUR POOLS

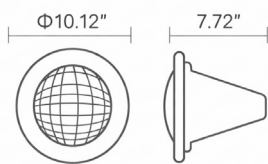

Featured Highlights

- Full-Spectrum Color Output
- Premium 316L Stainless Bezel
- Anti-UV & Anti-Corrosion Housing
- Flexible Customization Available

Ordering Information

Product	Model	Voltage	Wattage	Color	Material
03050101	LB0501	AC/DC12V AC120V	18W	Warm White / Cool White /RGB/ RGBW	316L Stainless Steel
03050102	LB0502	AC/DC12V AC120V	24W	Warm White / Cool White /RGB/ RGBW	316L Stainless Steel
03050103	LB0503	AC/DC12V AC120V	35W	Warm White / Cool White /RGB/ RGBW	316L Stainless Steel

LUMIBRITE PRO SERIES

LUXURY LIGHTING FOR YOUR POOLS

Featured Highlights

- Full-Spectrum Color Output
- Premium 316L Stainless Bezel
- Anti-UV & Anti-Corrosion Housing
- Flexible Customization Available

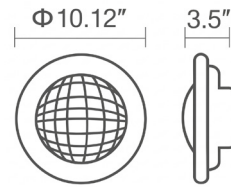

Ordering Information

Product	Model	Voltage	Wattage	Color	Material
03050104	LB0504	AC/DC12V AC120V	35W	Warm White / Cool White /RGB/ RGBW	316L Stainless Steel
03050105	LB0505	AC/DC12V AC120V	45W	Warm White / Cool White /RGB/ RGBW	316L Stainless Steel

LUMIBRITE PRO SERIES

LUXURY LIGHTING FOR YOUR POOLS



Featured Highlights

- Full-Spectrum Color Output
- Premium 316L Stainless Bezel
- Anti-UV & Anti-Corrosion Housing
- Flexible Customization Available

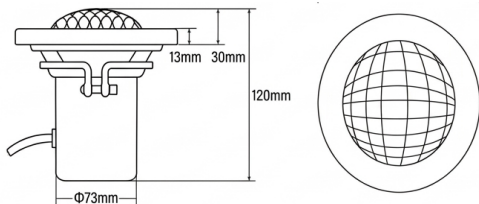

Ordering Information

Product	Model	Voltage	Wattage	Color	Material
03050106	LB0506	AC/DC12V AC120V	35W	Warm White / Cool White /RGB/ RGBW	316L Stainless Steel
03050107	LB0507	AC/DC12V AC120V	45W	Warm White / Cool White /RGB/ RGBW	316L Stainless Steel















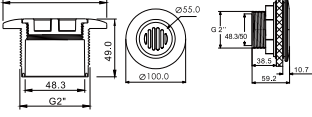

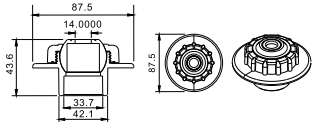

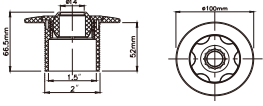
WATERWAVE

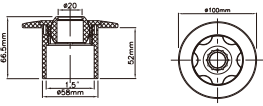
ACCESSORIES

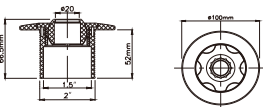
- ◆ AQUACORE SERIES
- ◆ AQUASKIM SERIES
- ◆ AQUAEDGE SERIES
- ◆ CASCADE PRO SERIES

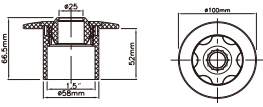

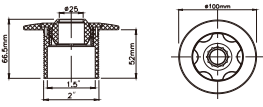

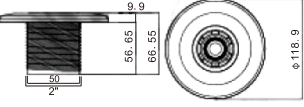





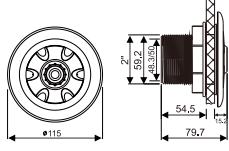

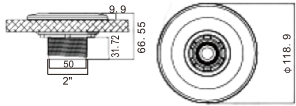

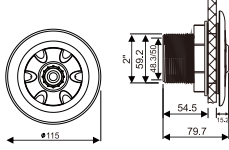
WATERWAVE AQUACORE POOL FITTINGS SERIES

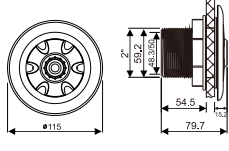
PRECISION POOL FITTINGS FOR LONG-LASTING PERFORMANCE

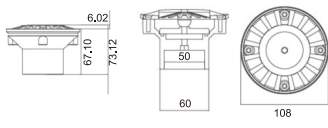
Image	Dimension	Model	Code
		AC021	04010121
		AC022	04010122
		AC023	04010123
		AC024	04010124
		AC025	04010125
		AC026	04010126
		AC027	04010127
		AC028	04010128

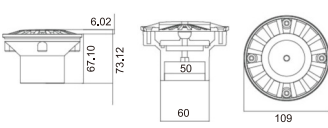

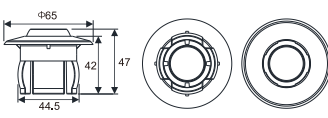

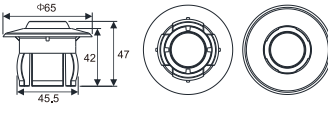





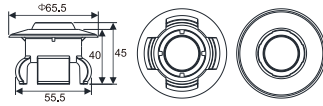

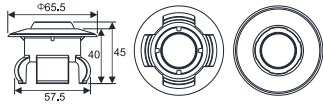
WATERWAVE AQUACORE POOL FITTINGS SERIES

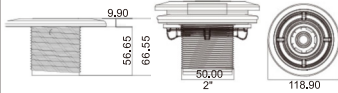
PRECISION POOL FITTINGS FOR LONG-LASTING PERFORMANCE

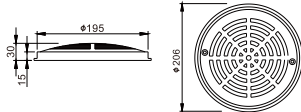
Image	Dimension	Model	Code
		AC029	04010129
		AC030	04010130
		AC031	04010131
		AC032	04010132
		AC033	04010133
		AC034	04010134
		AC035	04010135
		AC036	04010136

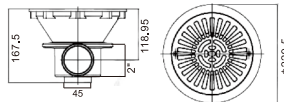

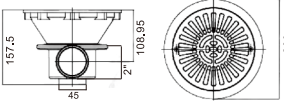

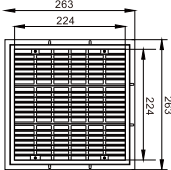
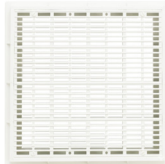
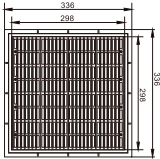





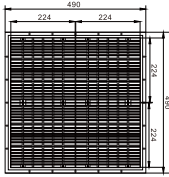

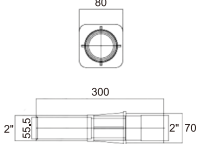
WATERWAVE AQUACORE POOL FITTINGS SERIES

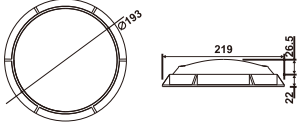
PRECISION POOL FITTINGS FOR LONG-LASTING PERFORMANCE

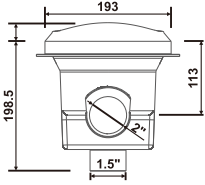
Image	Dimension	Model	Code
		AC037	04010137
		AC038	04010138
		AC039	04010139
		AC040	04010140
		AC041	04010141
		AC042	04010142
		AC043	04010143
		AC044	04010144

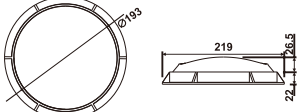

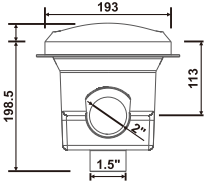

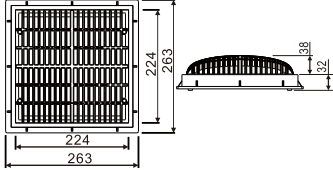
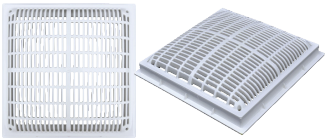
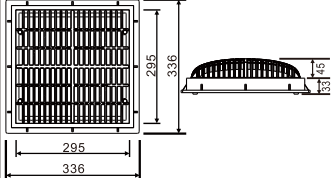
WATERWAVE AQUACORE POOL FITTINGS SERIES

PRECISION POOL FITTINGS FOR LONG-LASTING PERFORMANCE

Image	Dimension	Model	Code
		AC045	04010145
		AC046	04010146
		AC047	04010147
		AC048	04010148
		AC049	04010149
		AC050	04010150
		AC051	04010151
		AC052	04010152

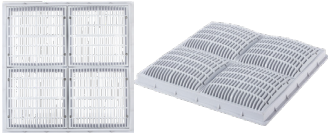
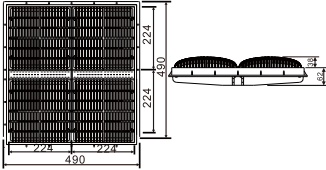
WATERWAVE AQUACORE POOL FITTINGS SERIES

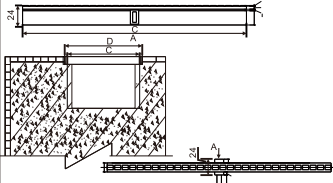
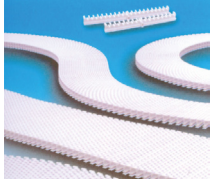
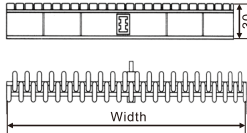
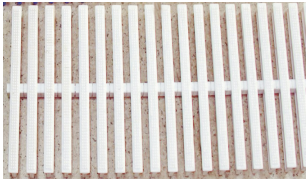
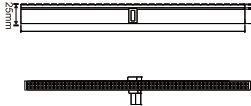
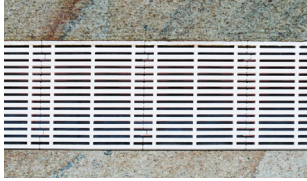
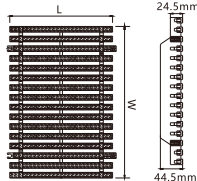
PRECISION POOL FITTINGS FOR LONG-LASTING PERFORMANCE

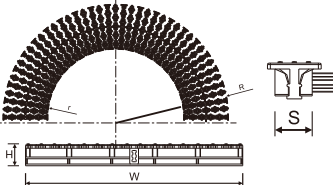
Image	Dimension	Model	Code
		AC053	04010153
		AC054	04010154
		AC055	04010155
		AC056	04010156
		AC057	04010157
		AC057	04010157

AQUASKIM CONCRETE PRO SERIES



Featured Highlights

- High-Durability Construction
- Fast Debris Skimming
- UV & Chemical Resistant
- Easy Installation & Low Maintenance

Ordering Information

Product	Model	Description
04030101	ASC001	Concrete Pool Skimmer
04030102	ASC002	Concrete Pool Skimmer
04030103	ASC003	Concrete Pool Skimmer
04030104	ASC004	Concrete Pool Skimmer
04030105	ASC005	Concrete Pool Skimmer
04030106	ASC006	Concrete Pool Skimmer
04030107	ASC007	Concrete Pool Skimmer
04030108	ASC008	Concrete Pool Skimmer
04030109	ASC009	Concrete Pool Skimmer

For additional product requirements, please feel free to contact us.

Dimensions

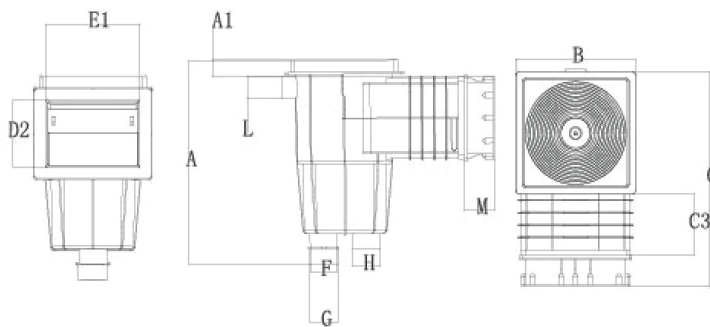

ASC001

Model	A	A1	B	C	C3	D2	E1	F	G	H	L	M
ASC001	416	25.31	248.9	435	137	136	196	48	58.7	56.6	40	59

*Size in mm

AQUASKIM CONCRETE PRO SERIES

Dimensions

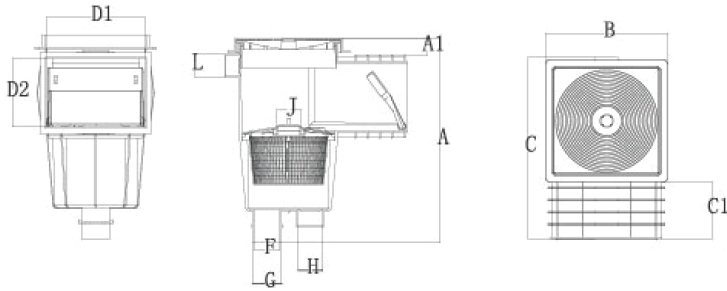

ASC002

Model	A	A1	B	C	C3	D2	E1	F	G	H	L	M
ASC002	416	34.60	248.90	370.20	156.38	201.7	139.7	48	58.7	50.00	40.00	49.76

* Size in mm

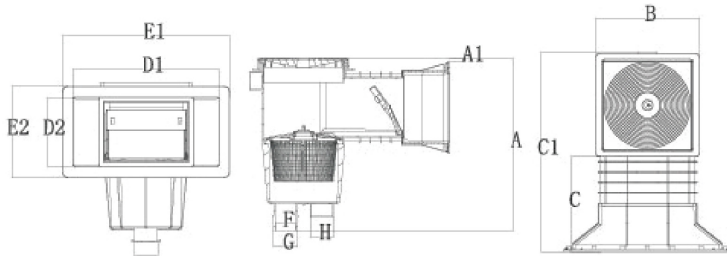

ASC003

Model	A	A1	B	C	C1	D1	D2	E1	E2	F	G	H
ASC003	416	8.75	249	229.6	483.7	352.6	167.3	405.3	220.3	48	58.7	2"

* Size in mm

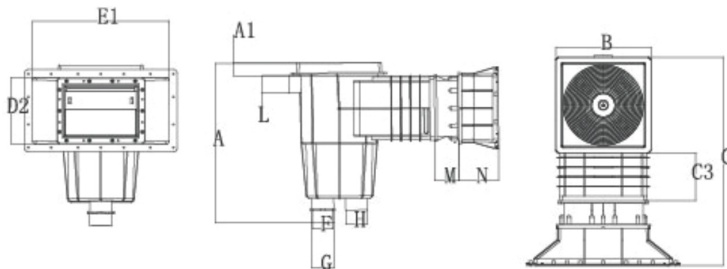

ASC004

Model	A	A1	B	C	C3	D3	E1	F	G	H	L	M	N
ASC004	416	25.31	248.9	550	137	172.5	358	48	58.7	2"	46	63	105

* Size in mm

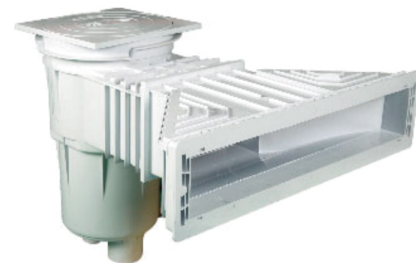
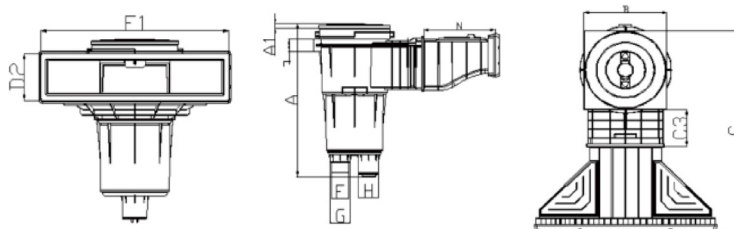

ASC005

Model	A	A1	B	C	C3	D2	E1	F	G	H	L	N
ASC005	483.8	14.5	250.3	634	117.4	136.6	551	45	60	70	33	249.2

* Size in mm

AQUASKIM CONCRETE PRO SERIES



Product Code	Product Description
ASC006	6" Thru-Wall Skimmer for Vinyl Pools
ASC007	Complete Thru-wall Skimmer w/ Flange Screw Cover & Inlet Winter Cover
ASC008	12" Wide Mouth Thru-Wall Skimmer for Vinyl Pools

AQUASKIM LINER PRO SERIES

Featured Highlights

- High-Durability Construction
- Fast Debris Skimming
- UV & Chemical Resistant
- Easy Installation & Low Maintenance



Ordering Information

Product	Model	Description
04030201	ASL001	Liner Pool Skimmer
04030202	ASL002	Liner Pool Skimmer
04030203	ASL003	Liner Pool Skimmer
04030204	ASL004	Liner Pool Skimmer
04030205	ASL005	Liner Pool Skimmer

For additional product requirements, please feel free to contact us.

Dimensions

ASL001

Model	A	A1	B	C	C3	D2	E1	F	G	H	L	M
ASL001	416	25.31	248.9	450	137	136	196	1 1/2"	2"	2"	46	73

*Size in mm

ASL002

Model	A	A1	B	C	C3	D2	E1	F	G	H	L
ASL002	416	25.31	248.9	400	137	136	196	1 1/2"	2"	2"	46

*Size in mm

AQUASKIM LINER PRO SERIES

Dimensions

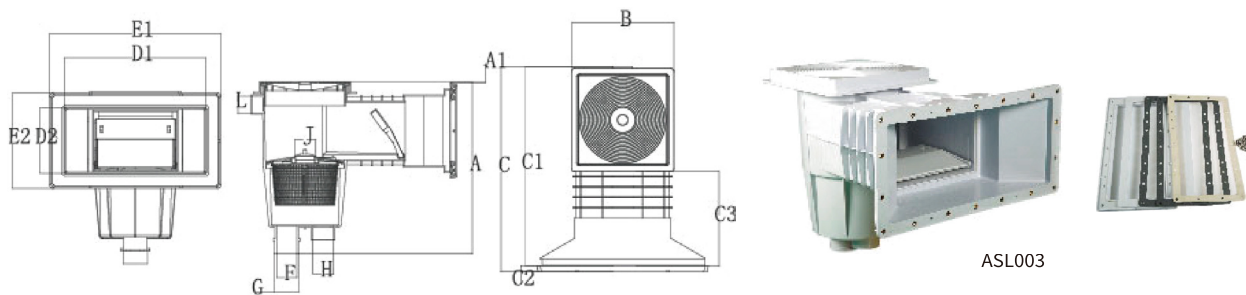

ASL003

Model	A	B	C	D1	D2	E1	E2	G	F	H	L	J	A1	C1	C2	C3
ASL003	416,00	214.82	496.94	341.38	156.38	415.00	230.00	2"	1 1/2"	50.00	40.00	49.76	3.40	481.94	15.00	227.34

*Size in mm

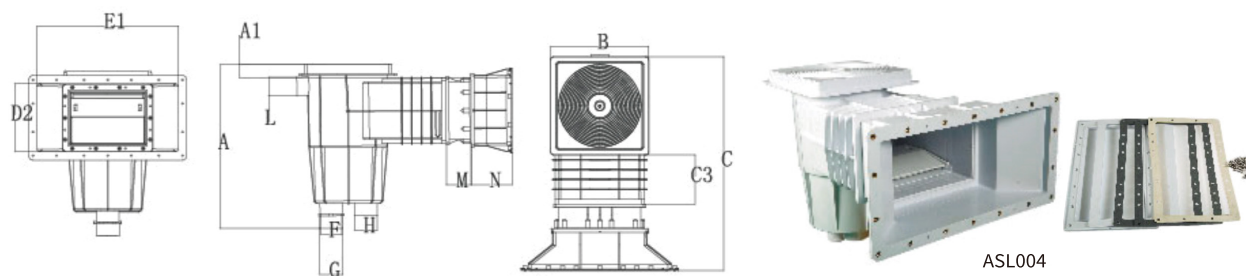

ASL004

Model	A	A1	B	C	C3	D2	E1	F	G	H	L	M	M
ASL004	416	25.31	248.9	565	137	172.5	358	1 1/2"	2"	2"	46	73	73

*Size in mm

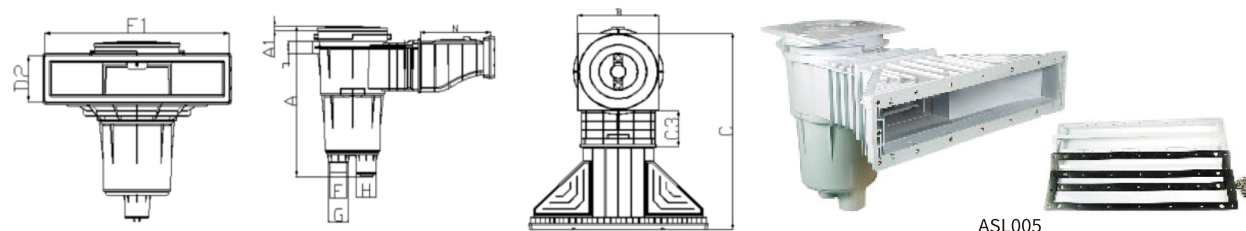

ASL005

Model	A	A1	B	C	C3	D2	E1	F	G	H	L	M
ASL005	483.8	14.5	250.3	634	117.4	136.6	551	45	60	70	38	249.2

*Size in mm

AQUAEDGE PRO SERIES

Featured Highlights

- Premium 316 Stainless Steel for superior corrosion resistance.
- Built for Strength & Longevity, even in harsh pool environments.
- Customizable Designs to match any pool style or project requirement.
- Optimized for athlete performance
- Strict quality control & professional-grade standards
- Clean, Modern Aesthetics that elevate the pool's visual appeal.
- Precision Manufacturing ensures safety, stability and long-term durability

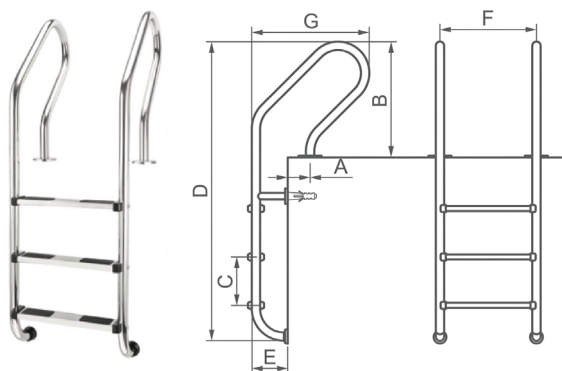

Ordering Information

Product	Model	Description
04030101	MM2	Mixed model ladder 2 Steps
04030102	MM3	Mixed model ladder 3 Steps
04030103	MM4	Mixed model ladder 4 Steps
04030104	MM5	Mixed model ladder 5 Steps

For additional product requirements, please feel free to contact us.

Dimensions

Model	Steps	A	B	C	D	E	F	G
MM2	2	120	620	250	1300	180	500	610
MM3	3	120	620	250	1550	180	500	610
MM4	4	120	620	250	1800	180	500	610
MM5	5	120	620	250	2050	180	500	610

*Size in mm

AQUAEDGE PRO SERIES

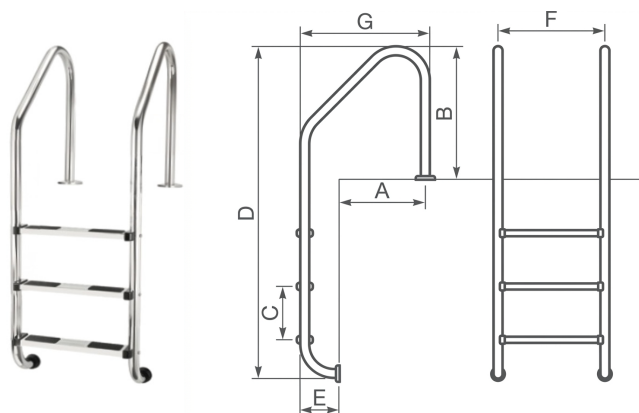

Featured Highlights

- Premium 316 Stainless Steel for superior corrosion resistance.
- Built for Strength & Longevity, even in harsh pool environments.
- Customizable Designs to match any pool style or project requirement.
- Optimized for athlete performance
- Strict quality control & professional-grade standards
- Clean, Modern Aesthetics that elevate the pool's visual appeal.
- Precision Manufacturing ensures safety, stability and long-term durability

Ordering Information

Product	Model	Description
04030201	SM2	Standard Model 2 Steps
04030202	SM3	Standard Model 3 Steps
04030203	SM4	Standard Model 4 Steps
04030204	SM5	Standard Model 5 Steps

For additional product requirements, please feel free to contact us.

Dimensions

Model	Steps	A	B	C	D	E	F	G
SM2	2	160	620	250	1330	180	500	360
SM3	3	160	620	250	1580	180	500	360
SM4	4	160	620	250	1830	180	500	360
SM5	5	160	620	250	2080	180	500	360

* Size in mm

AQUAEDGE PRO SERIES

Featured Highlights

- Premium 316 Stainless Steel for superior corrosion resistance.
- Built for Strength & Longevity, even in harsh pool environments.
- Customizable Designs to match any pool style or project requirement.
- Optimized for athlete performance
- Strict quality control & professional-grade standards
- Clean, Modern Aesthetics that elevate the pool's visual appeal
- Precision Manufacturing ensures safety, stability and long-term durability

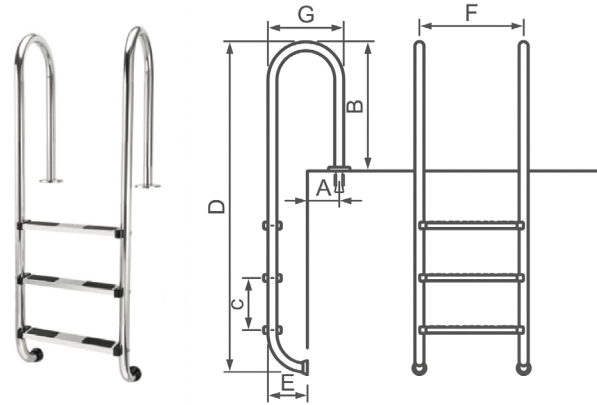

Ordering Information

Product	Model	Description
04030301	WM2	Wall Model 2 Steps
04030302	WM3	Wall Model 3 Steps
04030303	WM4	Wall Model 4 Steps
04030304	WM5	Wall Model 5 Steps

For additional product requirements, please feel free to contact us.

Dimensions

Model	Steps	A	B	C	D	E	F	G
WM2	2	410	620	250	1300	180	500	610
WM3	3	410	620	250	1550	180	500	610
WM4	4	410	620	250	1800	180	500	610
WM5	5	410	620	250	2050	180	500	610

*Size in mm

AQUAEDGE PRO SERIES

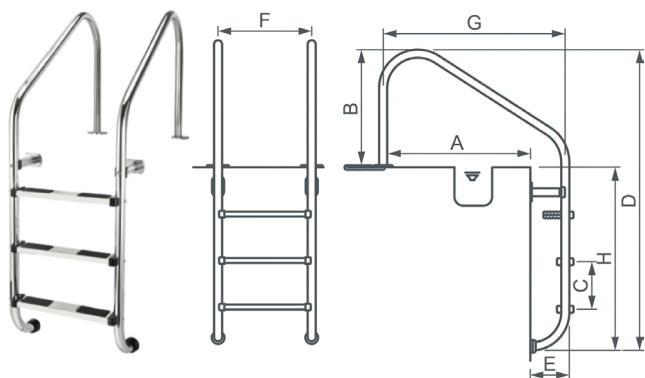

Featured Highlights

- Premium 316 Stainless Steel for superior corrosion resistance.
- Built for Strength & Longevity, even in harsh pool environments.
- Customizable Designs to match any pool style or project requirement.
- Optimized for athlete performance
- Strict quality control & professional-grade standards
- Clean, Modern Aesthetics that elevate the pool's visual appeal.
- Precision Manufacturing ensures safety, stability and long-term durability

Ordering Information

Product	Model	Description
04030401	OF2	Overflow Model 2 Steps
04030402	OF3	Overflow Model 3 Steps
04030403	OF4	Overflow Model 4 Steps
04030404	OF5	Overflow Model 5 Steps

For additional product requirements, please feel free to contact us.

Dimensions

Model	Steps	A	B	C	D	E	F	G	H
OF2	2	774	620	250	1335	200	500	957	715
OF3	3	774	620	250	1585	200	500	957	965
OF4	4	774	620	250	1835	200	500	957	1215
OF5	5	774	620	250	2085	200	500	957	1465

* Size in mm

WATERWAVE CASCADE PRO SERIES

Featured Highlights

- Premium 316 Stainless Steel for superior corrosion resistance.
- Built for Strength & Longevity, even in harsh pool environments.
- Customizable Designs to match any pool style or project requirement.
- Optimized for athlete performance
- Strict quality control & professional-grade standards
- Clean, Modern Aesthetics that elevate the pool's visual appeal.
- Precision Manufacturing ensures safety, stability and long-term durability

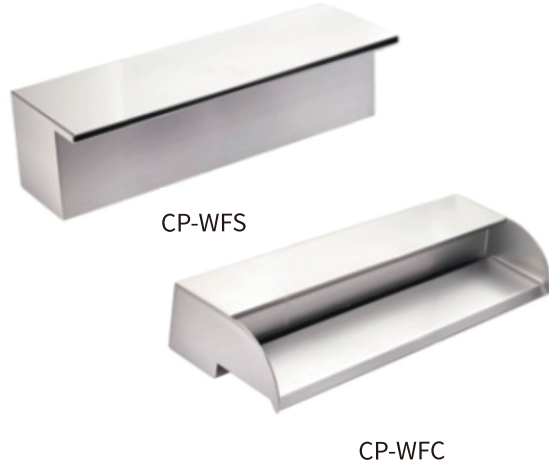

Ordering Information

Product	Model	Description
04040101	CP-CC	Stainless Steel 316/304
04040201	CP-AC	Stainless Steel 316/304
04040301	CP-HCC	Stainless Steel 316/304
04040401	ACP-SCC	Stainless Steel 316/304
04040501	CP-HFCP	Stainless Steel 316/304
04040601	CP-WF	Stainless Steel 316/304
04040701	CP-DH	Stainless Steel 316/304
04040801	CP-WFS	Stainless Steel 316/304
04040901	CP-WFC	Stainless Steel 316/304

For additional product requirements, please feel free to contact us.





WATERWAVE

MAINTENANCE EQUIPMENT

- ◆ PROCLEAN SERIES
- ◆ EASYCLEAN SERIES
- ◆ AUTOMATIC ROBOT SERIES















WATERWAVE PROCLEAN SERIES

PROFESSIONAL POOL CLEANING SOLUTIONS

Featured Highlights

- Professional-Grade Construction
- High-Efficiency Cleaning Performance
- Premium & Durable Materials
- Ergonomic & User-Friendly Design
- Modern & Stylish Appearance
- For Commercial & High-End Residential Pools

			
<p>PC001</p>	<p>PC002</p>	<p>PC003</p>	<p>PC004</p>
<p>05010101</p>	<p>05010102</p>	<p>05010103</p>	<p>05010104</p>
<p>14" Heavy-Duty Flexible Vacuum Head 6 Weights • SS Ball Bearing Wheels • Zinc Handle</p>	<p>14" Flexible Vacuum Head – IG Pools</p>	<p>19" Commercial Flexible Vacuum Head</p>	<p>18" Heavy-Duty Leaf Skimmer Reinforced Stiff Net</p>
			
<p>PC005</p>	<p>PC006</p>	<p>PC007</p>	<p>PC008</p>
<p>05010105</p>	<p>05010106</p>	<p>05010107</p>	<p>05010108</p>
<p>Deluxe Deep Leaf Rake Easy-Release Button</p>	<p>Professional Deluxe Deep Leaf Rake Squeegee Strip • Replaceable Net</p>	<p>20" Heavy-Duty Deep Leaf Rake Reinforced Stiff Net</p>	<p>18" Deluxe Wall Brush Aluminum Back</p>
			
<p>PC009</p>	<p>PC010</p>	<p>PC011</p>	<p>PC012</p>
<p>05010109</p>	<p>05010110</p>	<p>05010111</p>	<p>05010112</p>
<p>22" Heavy-Duty Pool Brush Nylon Bristles</p>	<p>8"–16" Heavy-Duty Telescopic Pole Twist-Lock Mechanism</p>	<p>EVA Spiral Vacuum Hose Ø38mm 25' • 30' • 40' • 50' • 65' • 100'</p>	<p>Vacuum Hose Reel Max Hose Length 13 m</p>

WATERWAVE PROCLEAN SERIES

PROFESSIONAL POOL CLEANING SOLUTIONS



PC013
05010113

Lovibond Scuba II
Electronic Pooltester



PC014
05010114

PoolLAB1.0
Handheld Water Quality Tester



PC015
05010115

Palintest
Pooltest 6 IMP406



WATERWAVE EASYCLEAN SERIES

SMART & AFFORDABLE POOL CLEANING















Featured Highlights

- Cost-Effective Performance
- Practical & Simple Design
- Reliable Daily Cleaning
- Lightweight & Easy Handling
- Durable Quality Materials
- For Residential & Budget Projects

			
<p>EC01 05020101</p>	<p>EC02 05020102</p>	<p>EC03 05020103</p>	<p>EC04 05020104</p>
<p>Materials: ABS Size: 28.2 * 23.5 * 9.2 cm</p>	<p>Materials: ABS Size: 28.5 * 29 * 10.5 cm</p>	<p>Materials: ABS Size: 35 * 26 * 9 cm</p>	<p>Materials: ABS Size: 34 * 25 * 10 cm</p>
			
<p>EC05 05020105</p>	<p>EC06 05020106</p>	<p>EC07 05020107</p>	<p>EC08 05020108</p>
<p>Materials: LDPE Size: 35.7 * 25.8 * 6 cm</p>	<p>Materials: LDPE Size: 39.6 * 25.2 * 6.5 cm</p>	<p>Materials: PE+ABS Size: 34.5 * 25 * 5.2 cm</p>	<p>Materials: EVA Size: 34.5 * 29.5 * 10.5 cm Aluminum Back</p>
			
<p>EC09 05020109</p>	<p>EC10 05020110</p>	<p>EC11 05020111</p>	<p>EC12 05020112</p>
<p>Materials: EVA Size: 47.7 * 29.5 * 15.5 cm</p>	<p>Materials: AL + ABS Size: 34.5 * 27 * 9.3 cm</p>	<p>Materials: AL + ABS Size: 45 * 27 * 9.3 cm</p>	<p>Materials: PE + PE net Size: 44.5 * 30.5 * 2.8 cm</p>

WATERWAVE EASYCLEAN SERIES

SMART & AFFORDABLE POOL CLEANING

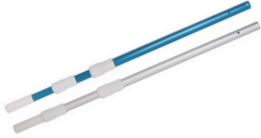
 <p>EC13 05020113</p> <p>Materials: PP + Nylon net Size: 54.5 * 41 * 4.55 cm</p>	 <p>EC14 05020114</p> <p>Materials: Alu + PE + PE net Size: 56.4 * 36 * 3 cm</p>	 <p>EC15 05020115</p> <p>Materials: Alu + Nylon net Size: 55.2 * 36 * 4 cm</p>	 <p>EC16 05020116</p> <p>Materials: ABS + AL + PE + PE net Size: 2 * 25.5 cm * 5 pcs</p>
 <p>EC17 05020117</p> <p>Materials: PE + PE net Size: 43.5 * 29.2 * 38.5 cm</p>	 <p>EC18 05020118</p> <p>Materials: Alu + PE net Size: 44.8 * 35 * 36.7 cm</p>	 <p>EC19 05020119</p> <p>Materials: PP + Nylon net Size: 51 * 41.5 * 36.6 cm</p>	 <p>EC20 05020120</p> <p>Materials: Alu + PE net Size: 44.8 * 35 * 36.7 cm</p>
 <p>EC21 05020121</p> <p>Materials: ABS + PP Size: 45 * 16.2 * 4.9 cm</p>	 <p>EC22 05020122</p> <p>Materials: ABS + PP Size: 45 * 16.2 * 4.9 cm</p>	 <p>EC23 05020123</p> <p>Materials: PP + ABS Size: 25.6 * 16.3 * 4.8 cm</p>	 <p>EC24 05020124</p> <p>Materials: AL + SS Size: 45.1 * 16.7 * 5.1 cm</p>
 <p>EC25 05020125</p> <p>Materials: ABS + SS + AL Size: 45.5 * 15 * 10.5 cm</p>	 <p>EC26 05020126</p> <p>Materials: SS 304 + ABS + POM Size: 25.6 * 16.3 * 4.8 cm</p>	 <p>EC27 05020127</p> <p>Materials: PP + AL Size: 43 * 11.5 * 15.5 cm</p>	 <p>EC28 05020128</p> <p>Standard grip & lock 2*120CM 2*180CM 2*240CM 3*100CM 3*120CM 3*150CM</p>

WATERWAVE PROCLEAN SERIES

PROFESSIONAL POOL CLEANING SOLUTIONS



EC29
05020129

Blow Molded Vacuum Hose with Standard Cuff
25' • 30' • 40' • 50' • 65' • 100'



EC30
05020130

Test kit refill bottle (20 C.C.)



EC31
05020131

Basic PH & CL test kit



EC32
05020132

5-way test kit refills for pool & spa (test Chlorine and Bromine, pH, Acid demand, Total Alkalinity)



EC33
05020133

5-way test kit for pool & spa test Chlorine, Bromine, pH, Acid demand, Total Alkalinity



EC34
05020134

3 in 1 Chlorine test strips test Free Chlorine, Total alkalinity and pH-50 strips



EC35
05020135

6 in 1 test strips (test total hardness, total chlorine, free chlorine PH total Alkalinity and cyanuric Acid)-50 strips



EC36
05020136

Economy Digital PH Meter



EC37
05020137

Test Tablets Kit (PH/ DPD) (20 tablets+ 20 tablets)



EC38
05020138

Jim Buoy Thermometer



EC39
05020139

Jumbo easy read thermometer



EC40
05020140

Floating animal thermometer in 4 styles



EC41
05020141

Round Thermometer



EC42
05020142

5" chemical dispenser for 1 1/2" tablets



EC43
05020143

7" chemical dispenser for 3" tablets



EC44
05020144

Deluxe 9" large chemical dispenser for 3" tablets

Robotic Pool Cleaners – Dolphin® by Maytronics

World-Leading Robotic Pool Cleaning Solutions

Featured Highlights

- Powered by Maytronics® Technology
- Intelligent Navigation & Coverage
- Powerful Active Brushing
- Energy Efficient Operation
- Easy Plug & Play
- Residential & Commercial Applications



M200 Plus

05020104

Ideal pool size: 15*8 metres
Smart Clean / Fine Filter



Liberty 200

05020101

Ideal pool size: 10*5 metres
Running Time 1.5 hours



Liberty 300

05020102

Ideal pool size: 10*5 metres
Running Time 1.5 hours
Eco Mode / Cycle Selector / Click-Up



Liberty 600

05020103

Ideal pool size: 15*5 metres
Running Time 4.5 hours
Eco Mode / App Support / Click-Up



Wave 90i

05020105

Ideal pool size: 20*8 metres
App Support / 3Cycle Options



Wave 100

05020106

Ideal pool size: 25*8 metres
3 Filtration / Cycle Options /
Semi-Standard



Wave 309

05020107

Ideal pool size: 50*25 metres
Triple - Level Filtration /
Full-Standard

WATERWAVE

SANITIZERS

- ◆ **AQUASALT SERIES**
- ◆ **UVFLOW SERIES**
- ◆ **INTELLICHEM SERIES**
- ◆ **INTELLIDOSE SERIES**

WATERWAVE AQUASALT SERIES

SMART SALTWATER CHLORINATION FOR EFFORTLESS POOL CARE

Featured Highlights

- Users can schedule up to three automatic operating periods per day, ensuring flexible and efficient chlorine production
- Energy-saving ECO operation reduces power consumption while maintaining stable pool sanitation
- Capable of continuous full-load operation to meet the demands of high bather-load pools
- The compact design allows quick installation — simply connect inlet/outlet pipes, power supply and add natural salt to start operation
- High-grade titanium plates with corrosion-resistant coating ensure excellent durability and reliable chlorine generation
- Converts natural salt into chlorine, providing soft, comfortable and naturally balanced pool water



WORKING CONDITIONS

- ⚠ Maximum Temperature: 0-50°C
- ⚠ Input Power: 220v 50Hz
- ⚠ Pool water salinity should be 3600 ppm or higher. For 100 m³ of pool water, add at least 36 kg of pure salt

Ordering Information

Product	Model	Max Chlorine Output	Voltage	Flow Switch	Recommended Pool Size(m ³)
06010101	AS35	35g/h	220-240V	Inlcuded	85
06010102	AS50	50g/h	220-240V	Inlcuded	125

WATERWAVE UVFLOW SERIES

PROFESSIONAL UV POOL DISINFECTION SYSTEMS

Featured Highlights

- Up to 8,000 Hours Service Life
- High-Transmittance Quartz Sleeve
- Intelligent Control Cabinet with Multi-Channel Output
- Real-Time Temperature Display & High-Temperature Alarm (55°C)
- Timer On/Off Function
- Dual Pump Control Output



Smart Control Panel



Ordering Information

Product	Model	Flow m ³ /h	Voltage V/Hz	Power W	Fitting Size	Dimension mm	Working Pressure Mpa
06020101	UF18	18	220 / 50	87	DN40	1080*100*220	0.7
06020102	UF30	30	220 / 50	174	DN40	1080*140*240	0.7
06020103	UF40	40	220 / 50	240	DN65	1390*170*320	0.7
06020104	UF60	60	220 / 50	360	DN80	1390*190*350	0.7

WATERWAVE INTELLICHEM SYSTEM

SMART POOL WATER QUALITY MONITORING & CHEMICAL DOSING CONTROLLER

Featured Highlights

- Real-time multi-parameter water quality monitoring
- Automatic chemical dosing control for pH and disinfectant levels
- High-precision electrochemical and optical sensors
- Large 7" industrial touchscreen interface
- Seamless integration with BMS and automation systems
- Reliable operation for commercial pool environments



System Specifications

Item	Specification
Display	7" High-Resolution Industrial Touchscreen
Controller Dimensions	600 × 500 × 230 mm
Enclosure Material	Industrial ABS
Protection Rating	IP68
Power Supply	220 VAC / 24 VDC
Dosing Pump Control	Standard 3 × 220 VAC dosing pump outputs (10A / 250V relay)
Communication Protocol	Modbus RTU (RS-485)
Integratio	Compatible with BMS and third-party automation platforms

Water Quality Measurement Parameters

Parameter	Measurement Range	Accuracy	Measurement Principle
pH	0 – 14 pH	±0.01 pH	Electrochemical Electrode
ORP	-2000 – 2000 mV	±1 mV	Electrochemical Electrode
Conductivity	0 – 20 mS/cm	±1% F.S	Conductive Method
Free Chlorine	0 – 20 mg/L	±5% F.S	Constant Voltage Amperometric
Free Chlorine (Membrane Sensor)	0 ~ 2 / 5 / 10 / 20 mg/L	±2% F.S	Membrane Method
Temperature	0 – 80°C	±0.1°C	RTD Resistance
Turbidity	0 – 3 NTU	±0.2 NTU	Optical Scattering Method
Dissolved Oxygen	0 – 20 mg/L	±1% F.S	Optical Method

Intelligent Control Functions

Automatic chlorine dosing control
pH level regulation
Real-time monitoring and alarm system
Water quality data tracking and analysis
Remote integration with pool automation systems
Stable operation for high bather load conditions

Typical Applications

Hotel & Resort Swimming Pools
Commercial Swimming Pools
Water Parks
School & Competition Pools
Luxury Residential Pools
Spa & Wellness Facilities

IntelliDose Series Controller Configurations

Product	Model	Typical Application	Monitoring Parameters
06030101	IC03	Standard Pool Monitoring	pH · Free Chlorine · Temperature
06030102	IC04	Advanced Water Quality Control	pH · ORP · Free Chlorine · Temperature
06030103	IC05	Professional Multi-Parameter Monitoring	pH · ORP · Free Chlorine · Turbidity · Temperature

WATERWAVE INTELLIDOSE SERIES

PRECISION CHEMICAL DOSING PUMPS

Featured Highlights

- Advanced electromagnetic metering technology ensures accurate and stable chemical injection
- Compatible with chlorine, acid and other common pool treatment chemicals
- Corrosion-resistant pump head and components designed for long-term operation
- User-friendly control interface with stable and consistent dosing output
- Space-saving design ideal for pool equipment rooms and integrated control systems



Typical Selection Guide

Product	Model	Max Capacity	Pressure	Max Injection Rate	Typical Pool Volume	Typical Application
06040101	ICP09	9 L/h	2 Bar	150 ml/min	Up to 120 m ³	Residential pools
06040102	ICP18	18 L/h	2 Bar	300 ml/min	Up to 250 m ³	Villas / boutique hotels
06040103	ICP54	54 L/h	2 Bar	900 ml/min	Up to 700 m ³	Commercial pools

Selection Guide

Choose the appropriate pump model based on pool volume, chemical concentration, and dosing demand.

Dimensions

Model	MC-9	MC-18 MC-54
A	180	228
B	154	190
C	99	118
D	72	88
E	98	100
F	98	100
G	70	70
H	13	13
I	9	9

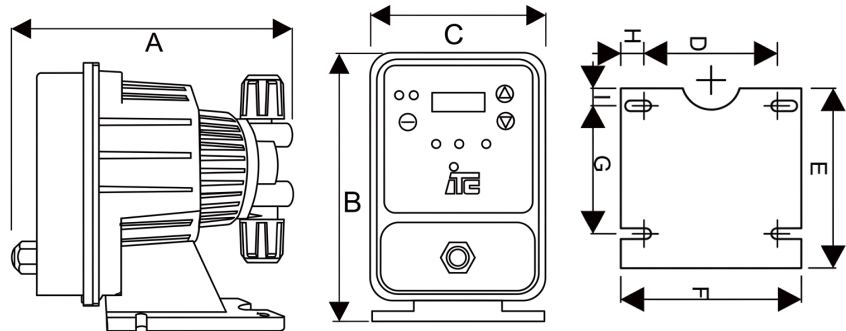

 WATERWAVE

WELLNESS

- ◆ HARVIA SAUNA SERIES
- ◆ TIMBERTHERM SERIES
- ◆ HARVIA STEAM SERIES
- ◆ STEAM FLOW SERIES
- ◆ HYDROTHERAPY WH SERIES
- ◆ AQUAFIT EVOLUTION SERIES
- ◆ ACUA MOTION SERIES

HARVIA SAUNA HEATING SOLUTIONS

TRADITION, QUALITY & PERFORMANCE FROM FINLAND

Featured Highlights

- Finnish Brand with Over 70 Years Heritage
- Fast & Stable Heating Performance
- Optimized Stone Capacity for Soft & Even Steam
- Durable Stainless Steel Heating Elements
- Suitable for Residential & Commercial Saunas
- Energy Efficient & Reliable Operation

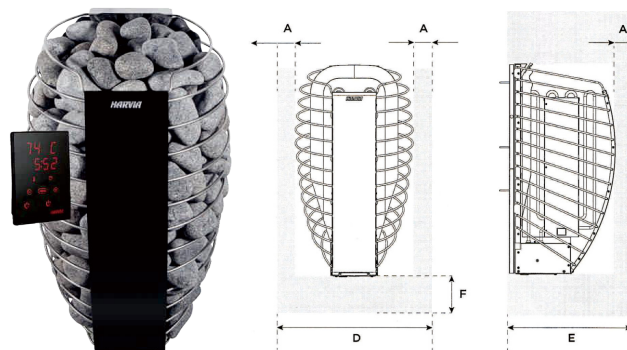

Ordering Information

Product	Description	Power Kw	Suitable Sauna Room Area m ²	Dimensions (L × W × H) mm	Stone Capacity Ø5-10cm Kg	400V 3N~		230V 1N~		Min. Safety Distance mm			
						Cable Size mm ²	Fuse A	Cable Size mm ²	Fuse A	A	B	C	D
07010101	SP60XW	6.0	5.0-9.0	334*385*687	60.00	5*1.5	3*10	3*6	1*35	60	505	394	100-300
07010102	SP90XW	9.0	8.0-14.0	334*385*687	60.00	5*2.5	3*16	3*10	/	80	545	414	100-300

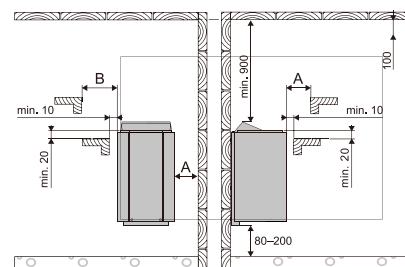

Ordering Information

Product	Description	Power Kw	Suitable Sauna Room Area m ²	Dimensions (L × W × H) mm	Stone Capacity Ø5-10cm Kg	230V 1N~		Min. Safety Distance (Point A) mm	Min. Safety Distance (Point B) mm
						Cable Size mm ²	Fuse A		
07010103	BC23	2.3	1.3-2.5	295*280*505	12.00	3*2.5	2*10	10	20
07010104	BC23E	2.3	1.3-2.5	295*280*505	12.00	3*2.5	2*10	10	20
07010105	BC35	3.5	2-4.5	295*280*505	12.00	3*2.5	2*10	10	20
07010106	BC35E	3.5	2-4.5	295*280*505	12.00	3*2.5	2*10	10	20

HARVIA SAUNA HEATING SOLUTIONS

TRADITION, QUALITY & PERFORMANCE FROM FINLAND

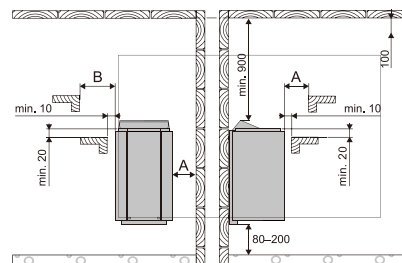

Ordering Information

Product	Description	Power Kw	Suitable Sauna Room Area m ²	Dimensions (L × W × H) mm	Stone Capacity Ø5-10cm Kg	400V 3N~		230V 1N~	
						Cable Size mm ²	Fuse A	Cable Size mm ²	Fuse A
07010107	BC45	4.5	3.0-6.0	480*310*540	20.00	5*1.5	3*10	3*2.5	1*20
07010108	BC45E	4.5	3.0-6.0	480*310*540	20.00	5*1.5	3*10	3*2.5	1*20
07010109	BC60	6.0	5.0-8.0	480*310*540	20.00	5*1.5	3*10	3*4.0	1*35
07010110	BC60E	6.0	5.0-8.0	480*310*540	20.00	5*1.5	3*10	3*4.0	1*35
07010111	BC80	8.0	7.0-12.0	480*310*540	20.00	5*2.5	3*16	/	/
07010112	BC80E	6.0	5.0-8.0	480*310*540	20.00	5*2.5	3*16	/	/
07010113	BC90	9.0	8.0-14.0	480*310*540	20.00	5*2.5	3*16	/	/
07010114	BC90E	9.0	8.0-14.0	480*310*540	20.00	5*2.5	3*16	/	/

HARVIA SAUNA HEATING SOLUTIONS

TRADITION, QUALITY & PERFORMANCE FROM FINLAND

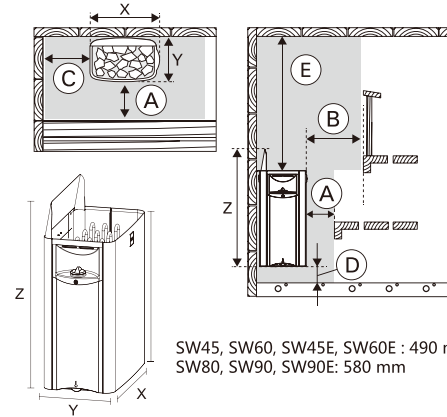

SW45, SW60, SW45E, SW60E : 490 mm
SW80, SW90, SW90E: 580 mm

Ordering Information

Product	Description	Power Kw	Suitable Sauna Room Area m ²	Dimensions (L × W × H) mm	Weight	Stone Capacity Ø5-10cm Kg	Min. Safety Distance mm				
							A	B	C	D	E
07010115	SW45	4.5	3.0-6.0	430*260*610	11.1	20	20	35	35	80	1200
07010116	SW45E	4.5	3.0-6.0	380*260*610	9.2	20	20	0.2	0.2	80	1200
07010117	SW60	6.0	5.0-8.0	430*260*610	11.6	20	30	40	40	80	1200
07010118	SW60E	6.0	5.0-8.0	380*260*610	9.7	20	30	40	50	80	1200
07010119	SW80	8.0	7.0-12.0	430*260*700	13.6	20	30	70	70	80	1200
07010120	SW90	9.0	8.0-14.0	430*260*700	13.6	20	30	70	80	80	1200
07010121	SW90E	9.0	8.0-14.0	380*260*700	10.7	20	30	80	80	80	1200

WATERWAVE TIMBERTHERM SERIES

CRAFTED FROM PREMIUM CANADIAN HEMLOCK & RED CEDAR FOR
PURE, LONG-LASTING SAUNA WELLNESS

Featured Highlights

- **Premium Canadian Wood**
Century-grown Hemlock & Red Cedar, naturally antibacterial and rot-resistant
- **Natural Phytoncide Aroma**
Soothing wood fragrance for deep relaxation
- **Advanced Drying Treatment**
Precision kiln-dried to prevent cracking and deformation
- **Exceptional Structural Stability**
Designed to withstand humidity and temperature fluctuations
- **Long Service Life**
Engineered durability with a lifespan of over 20 years

Available Wood Species



Finnish Spruce



Obeche



Hemlock



Canadian Cedar



Burmese Cedar



Aspen



Yellow Cypress

Bench Components



Finnish Spruce



Obeche

WATERWAVE TIMBERTHERM SERIES

CRAFTED FROM PREMIUM CANADIAN HEMLOCK & RED CEDAR FOR
PURE, LONG-LASTING SAUNA WELLNESS

Standard Board Dimensions

Product Type	Thickness	Width	Standard Length
Wall Panel	12 mm	95 mm	2000 / 2100 / 2135 / 2440 mm
Bench Board	18–20 mm	95 mm	2000 / 2100 / 2135 / 2440 mm
Floor Board	18–20 mm	41 mm	2000 / 2100 / 2135 / 2440 mm

Custom Manufacturing Available

All sauna timber components can be customized according to project requirements, including:

- ✓ Custom lengths
- ✓ Special profiles
- ✓ Decorative trims
- ✓ Project-specific sauna interior solutions



WT0101

Code 07010201

200 × 200 × 210 cm (W × D × H)



WT0102

Code 07010202

200 × 200 × 210 cm (W × D × H)



WT0103

Code 07010203

220 × 220 × 210 cm (W × D × H)



WT0104

Code 07010204

200 × 200 × 210 cm (W × D × H)



WT0105

Code 07010205

180 × 150 × 210 cm (W × D × H)



WT0106

Code 07010206

200 × 180 × 210 cm (W × D × H)



WT0107

Code 07010207

200 × 150 × 210 cm (W × D × H)



WT0108

Code 07010208

200 × 200 × 210 cm (W × D × H)



WT0109

Code 07010209

100 × 100 × 210 cm (W × D × H)



WT0110

Code 07010210

90 × 90 × 190 cm (W × D × H)



WT0111

Code 07010211

120 × 100 × 190 cm (W × D × H)











WT0112

Code 07010212

120 × 100 × 190 cm (W × D × H)

WATERWAVE TIMBERTHERM SERIES

CRAFTED FROM PREMIUM CANADIAN HEMLOCK & RED CEDAR FOR
PURE, LONG-LASTING SAUNA WELLNESS

 <p>WT0113 Code 07010213 150 × 100 × 190 cm (W × D × H)</p>	 <p>WT0114 Code 07010214 180 × 120 × 190 cm (W × D × H)</p>	 <p>WT0115 Code 07010215 90 × 90 × 190 cm (W × D × H)</p>	 <p>WT0116 Code 07010216 120 × 100 × 190 cm (W × D × H)</p>
 <p>WT0117 Code 07010217 150 × 100 × 190 cm (W × D × H)</p>	 <p>WT0118 Code 07010218 180 × 120 × 190 cm (W × D × H)</p>	 <p>WT0119 Code 07010219 150 × 120 × 190 cm (W × D × H)</p>	 <p>WT0120 Code 07010220 90 × 90 × 190 cm (W × D × H)</p>
 <p>WT0121 Code 07010221 120 × 100 × 190 cm (W × D × H)</p>			

Discover more bespoke sauna creations—get in touch with us today.

HARVIA STEAM SOLUTIONS

PURE STEAM, COMFORT & WELL-BEING FROM FINLAND

Featured Highlights

- Finnish Brand with Over 70 Years of Wellness Heritage
- Comfortable Low-Temperature High-Humidity Steam
- Stable & Consistent Steam Output
- Supports Relaxation, Circulation & Respiratory Comfort
- Suitable for Residential & Commercial Steam Rooms
- Reliable & Energy-Efficient Operation



Ordering Information

Product	Description	Power	Steam Output kg/h	230V 1N~		400V 3N~	
				Cable	Fuse	Cable	Fuse
				mm ²	A	mm ²	A
07020101	HGS45	4.5	5.5	3 × 6	25	5 × 1.5	3 × 10
07020102	HGS60	5.7	7.6	3 × 6	25	5 × 1.5	3 × 10
07020103	HGS90	9.0	12	/	/	5 × 2.5	3 × 16
07020104	HGS110	10.8	14.6	/	/	5 × 2.5	3 × 16

Overall dimensions (W × D × H): 520 × 196 × 411 mm

Recommended Room Size (m³)

Plastic Panel Walls		Thin Tiled Walls		Solid Stone / Tile Walls	
Ventilated	Non-Ventilated	Ventilated	Non-Ventilated	Ventilated	Non-Ventilated
2-5	2-7	2-4	2-6	2-3.5	2-4.5
2.5-8	3.5-11	2-6	3-9	2-5	2-7.5
6-12	9-17	4.5-10	7.5-14	3-8	6-11.5
10-14.5	15-21	8-12	12-17	6-10	10-14

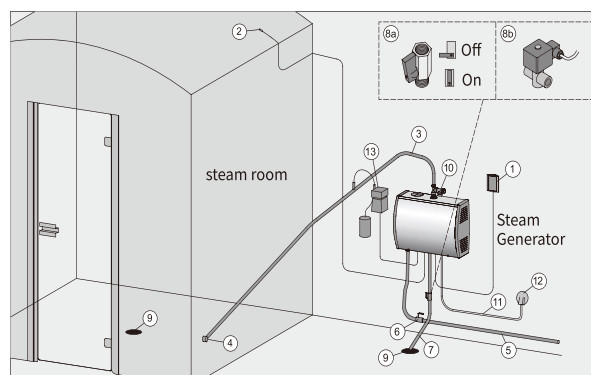

Steam Generator Accessories

- | | |
|-----------------------|-------------------------------|
| 1. Controller | 8a. Manual Drain Valve |
| 2. Temperature Sensor | 8b. Automatic Drain Valve |
| 3. Steam Pipe | 9. Floor Drain |
| 4. Steam Nozzle | 10. Overpressure Safety Valve |
| 5. Water Supply Pipe | 11. Power Cable |
| 6. Water Supply Valve | 12. Junction Box |
| 7. Drain Pipe | 13. Aroma Pump (Optional) |

HARVIA STEAM SOLUTIONS

TRADITION, QUALITY & PERFORMANCE FROM FINLAND



Ordering Information

Product	Description	Power	Steam Output kg/h	230V 1N~		400V 3N~	
				Cable	Fuse	Cable	Fuse
				mm ²	A	mm ²	A
07020105	HGX2	2.2	2	3 × 1.5	10	/	/
07020106	HGX45	4.5	5.5	3 × 6	25	5 × 1.5	3 × 10
07020107	HGX60	5.7	7.6	3 × 6	25	5 × 1.5	3 × 16
07020108	HGX90	9.0	12.0	/	/	5 × 1.5	3 × 16
07020109	HGX11	10.8	14.6	/	/	5 × 2.5	3 × 16
07020110	HGX15	15.0	20.1	/	/	5 × 6	3 × 25

Overall dimensions (W × D × H): 600 × 155 × 320 mm
 Net weight: 9 kg (empty)
 Operating weight: 13 kg (full)

Recommended Room Size (m ³)					
Plastic Panel Walls		Thin Tiled Walls		Solid Stone / Tile Walls	
Ventilated	Non-Ventilated	Ventilated	Non-Ventilated	Ventilated	Non-Ventilated
2-4	2-4	2-4	2-4	2-4	2-4
2-5	2-7	2-4	2-6	2-3.5	2-4.5
2.5-8	3.5-11	2-6	3-9	2-5	2-7.5
6-12	9-17	4.5-10	7.5-14	3-8	6-11.5
10-14.5	15-21	8-12	12-17	6-10	10-14
12-19.5	17-28	10-16	14-23	8-13.5	12-18

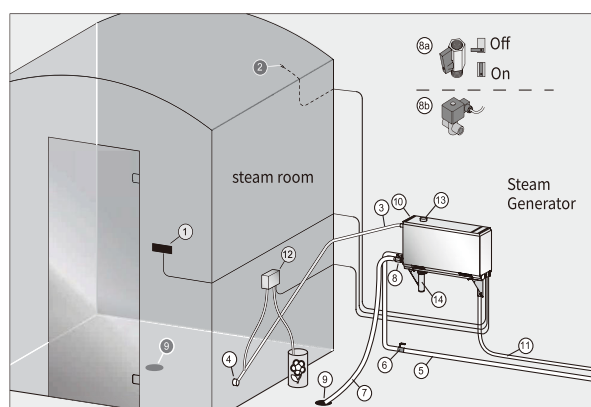

Steam Generator Accessories

1. Controller
2. Temperature Sensor
3. Steam Pipe
4. Steam Nozzle
5. Water Supply Pipe
6. Water Supply Valve
7. Drain Pipe
- 8a. Manual Drain Valve
- 8b. Automatic Drain Valve
9. Floor Drain
10. Overpressure Safety Valve
11. Power Cable
12. Aroma Pump (Optional)
13. Top Rubber Plug
14. Scale Sedimentation Cup

HARVIA STEAM SOLUTIONS

PURE STEAM, COMFORT & WELL-BEING FROM FINLAND

Featured Highlights

- Finnish Brand with Over 70 Years of Wellness Heritage
- Comfortable Low-Temperature, High-Humidity Steam
- Stable & Consistent Steam Output
- Supports Relaxation, Circulation & Respiratory Comfort
- Suitable for Residential & Commercial Steam Rooms
- Reliable & Energy-Efficient Operation



Ordering Information

Product	Description	Power	Steam Output kg/h	230V 1N~		400V 3N~	
				Cable	Fuse	Cable	Fuse
				mm ²	A	mm ²	A
07020111	HGS45	4.5	5.5	3 × 6	25	5 × 1.5	3 × 10
07020112	HGS60	5.7	7.6	3 × 6	25	5 × 1.5	3 × 10
07020113	HGS90	9.0	12	/	/	5 × 2.5	3 × 16
07020114	HGS110	10.8	14.6	/	/	5 × 2.5	3 × 16
07020115	HGS150	15.0	20.1	/	/	5 × 2.5	3 × 25

Overall dimensions (W × D × H): 460 × 210 × 435 mm

Recommended Room Size (m³)

Plastic Panel Walls		Thin Tiled Walls		Solid Stone / Tile Walls	
Ventilated	Non -Ventilated	Ventilated	Non -Ventilated	Ventilated	Non -Ventilated
2-5	2-7	2-4	2-6	2-3.5	2-4.5
2.5-8	3.5-11	2-6	3-9	2-5	2-7.5
6-12	9-17	4.5-10	7.5-14	3-8	6-11.5
10-14.5	15-21	8-12	12-17	6-10	10-14
12-19.5	17-28	10-16	14-23	8-13.5	12-18.5

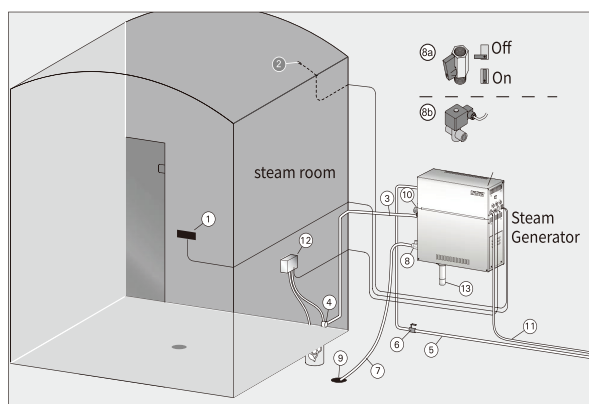

Steam Generator Accessories

1. Controller
2. Temperature Sensor
3. Steam Pipe
4. Steam Nozzle
5. Water Supply Pipe
6. Water Supply Valve
7. Drain Pipe
- 8a. Manual Drain Valve
- 8b. Automatic Drain Valve
9. Floor Drain
10. Overpressure Safety Valve
11. Power Supply Cable
12. Aroma Pump (Optional)
13. Scale Sedimentation Cup

HARVIA STEAM SOLUTIONS

TRADITION, QUALITY & PERFORMANCE FROM FINLAND



Ordering Information

Product	Description	Power	Steam Output kg/h	230V 1N~		400V 3N~	
				Cable	Fuse	Cable	Fuse
				mm ²	A	mm ²	A
07020116	HGP22	21.6	29.2	/	/	2 × 5 × 6	2 × 3 × 16
07020117	HGP30	30.0	40.2	/	/	2 × 5 × 6	2 × 3 × 25

Recommended Room Size (m ³)					
Plastic Panel Walls		Thin Tiled Walls		Solid Stone / Tile Walls	
Ventilated	Non -Ventilated	Ventilated	Non -Ventilated	Ventilated	Non -Ventilated
20-29	30-42	16-24	24-34	12-20	20-28
24-39	34-56	20-32	28-46	16-27	24-37

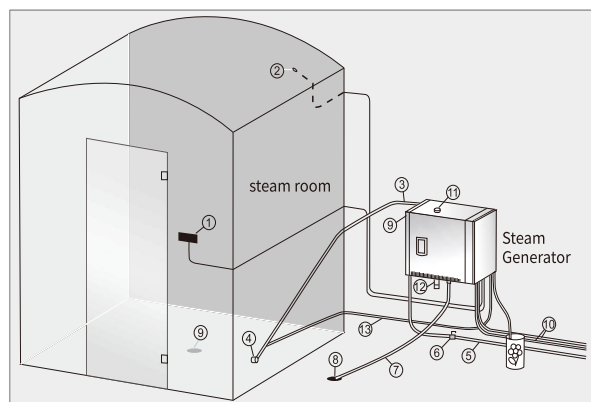

Steam Generator Accessories

1. Controller
2. Temperature Sensor
3. Steam Pipe
4. Steam Nozzle
5. Water Supply Pipe
6. Water Supply Valve
7. Drain Pipe
8. Floor Drain
9. Overpressure Safety Valve
10. Power Cable
11. Top Rubber Plug
12. Scale Sedimentation Cup
13. Aroma Output Pipe

WATERWAVE STEAMFLOW STEAM ROOM SERIES

ENGINEERED STEAM ENCLOSURES FOR RESIDENTIAL & COMMERCIAL WELLNESS

Featured Highlights

- **Tempered Safety Glass**
High-strength glass designed for safety, durability and a clean modern appearance
- **Premium Acrylic Panels**
Smooth, moisture-resistant surfaces built for long-term steam environments
- **304 Stainless Steel / Aluminum Alloy Structure**
Corrosion-resistant frame ensuring stability and long service life
- **Intelligent Control System**
Smart digital controller with simple and intuitive operation
- **Temperature & Time Adjustment**
Precise control for a personalized and comfortable steam experience

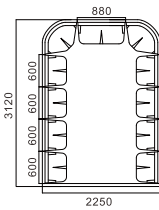

WS0201

Code 07020201

2250 × 3120 × 2150 mm (W × D × H)

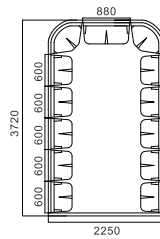

WS0202

Code 07020202

2250 × 3720 × 2150 mm (W × D × H)

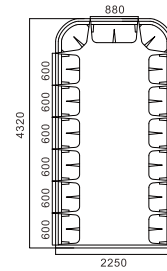

WS0203

Code 07020203

2250 × 4320 × 2150 mm (W × D × H)

WATERWAVE STEAMFLOW STEAM ROOM SERIES

ENGINEERED STEAM ENCLOSURES FOR RESIDENTIAL & COMMERCIAL WELLNESS

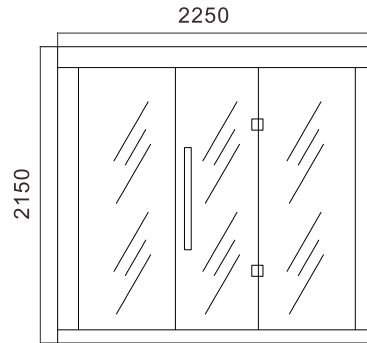

WS0204
Code 07020204
2250 × 1920 × 2150 mm (W × D × H)

WS0205
Code 07020205
2250 × 4920 × 2150 mm (W × D × H)

WS0206
Code 07020206
2250 × 5520 × 2150 mm (W × D × H)

WS0207
Code 07020207
2250 × 6120 × 2150 mm (W × D × H)

WATERWAVE STEAMFLOW STEAM ROOM SERIES

ENGINEERED STEAM ENCLOSURES FOR RESIDENTIAL & COMMERCIAL WELLNESS

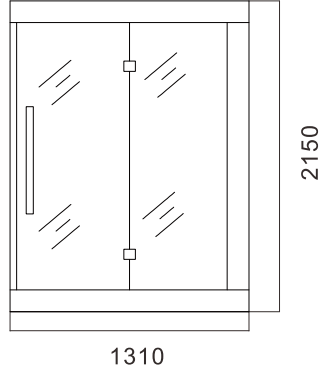

WS0208
Code 07020208
1310 × 1140 × 2150 mm (W × D × H)

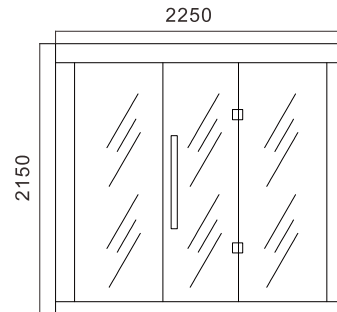

WS0204
Code 07020204
2250 × 1320 × 2150 mm (W × D × H)

WS0205
Code 07020205
2250 × 252 × 2150 mm (W × D × H)

WATERWAVE HYDROTHERAPY WH SERIES



Advanced Hydrotherapy Jets

Precision-engineered jets deliver targeted massage to relax muscles and relieve tension



Ergonomic Seating Design

Precision-engineered jets deliver targeted massage to relax muscles and relieve tension



Durable Acrylic Construction

UV-resistant and chemical-resistant materials ensure long service life



Energy-Efficient Heating System

Maintains stable water temperature with reduced energy consumption



Elegant Modern Design

Clean lines and premium finishes complement modern outdoor living spaces

SPA EXPERIENCE



**Improved blood
circulation**



Muscle relaxation



**Enhanced bathing
comfort**



**Stress relief and
mental relaxation**



**Overall wellness
support**

Waterwave spas are designed to create a perfect balance between powerful hydrotherapy and comfortable seating, offering a relaxing experience for both body and mind

LUXURY SWIM SPA EXPERIENCE



Designed for both exercise and relaxation, the WH01 Swim Spa combines a powerful swim training system with therapeutic hydro-massage jets.

Its generous length and spacious interior create the perfect environment for fitness training, hydrotherapy and premium outdoor wellness.

Technical Specifications

Item	Specification
Product Code	07030101
Model	WH01
Dimensions	7000 × 2400 × 1470 mm
Hydrotherapy Jets	56
Lighting	LED Underwater Lighting
Application	Fitness · Hydrotherapy · Relaxation

Key Features

Professional Swim Training

Integrated counter-current system creates a strong and adjustable water flow for effective swim exercise and endurance training

Deep Hydrotherapy Massage

Multiple strategically positioned massage jets help relieve muscle tension and improve circulation

Spacious Wellness Area

Extra-long spa design allows comfortable stretching, floating and relaxation after training

Elegant LED Lighting

Integrated underwater LED lights create a refined atmosphere for evening relaxation

PREMIUM SWIM SPA

The WH02 is designed for both active swimming and deep hydrotherapy relaxation.

Its elongated spa layout offers a balanced combination of swim training, massage therapy, and outdoor wellness living, making it ideal for modern private villas and resort environments.



Technical Specifications

Item	Specification
Product Code	07030102
Model	WH02
Dimensions	5800 × 2200 × 1550 mm
Product Type	Swim Spa
Application	Fitness · Hydrotherapy · Relaxation

Key Features

Swim Training Experience

Integrated counter-current system enables smooth swimming exercise and endurance training

Hydrotherapy Massage Jets

Strategically positioned jets deliver targeted massage to relax muscles and improve circulation

Spacious Relaxation Zone

Extended interior layout provides comfortable space for stretching, floating and unwinding

Elegant Outdoor Spa Design

Clean architectural lines and integrated lighting enhance any terrace or garden setting

LUXURY HYDROTHERAPY SPA



The WH03 is crafted for immersive hydrotherapy and comfortable body relaxation.

Its ergonomic interior and massage configuration create a perfect space for daily wellness, muscle recovery and luxury spa enjoyment.

Technical Specifications

Item	Specification
Product Code	07030103
Model	WH03
Dimensions	5500 × 2200 × 1550 mm
Optional Length	5150 mm
Product Type	Hydrotherapy Spa
Application	Relaxation · Hydrotherapy · Wellness

Key Features

Ergonomic Hydrotherapy Seating

Designed seating contours support the body while delivering targeted massage therapy

Deep Muscle Relaxation

Multiple hydrotherapy jets help relieve stress and reduce muscle fatigue

Modern Outdoor Spa Styling

Clean lines and contemporary cabinet design blend beautifully with modern outdoor architecture

Relaxation-Focused Design

Ideal for quiet personal wellness sessions or small family spa experiences

GRAND FAMILY SPA

The WH04 is designed for spacious family relaxation and shared wellness experiences.

Its generous spa layout provides a comfortable environment for hydrotherapy, leisure and premium outdoor living.

Technical Specifications

Item	Specification
Code	07030104
Model	WH04
Dimensions	3100 × 2200 × 950 mm
Product Type	Family Spa
Application	Relaxation · Hydrotherapy · Social Wellness

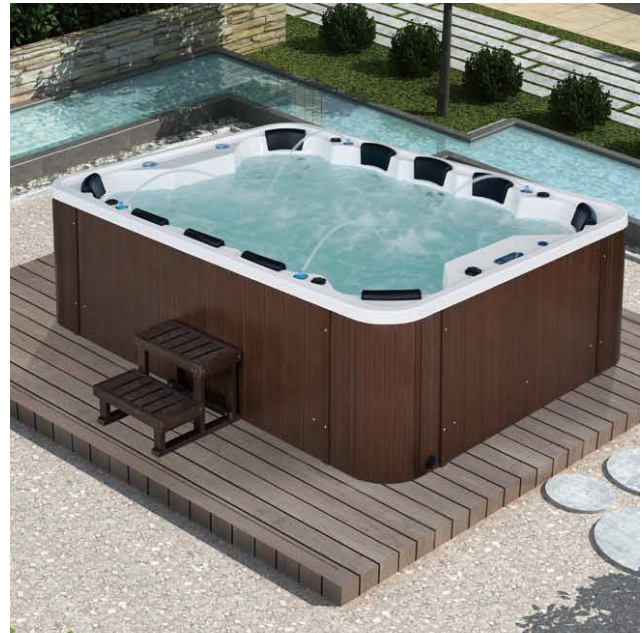

Key Features

Spacious Family Layout

Large interior space allows multiple users to relax comfortably and enjoy shared spa moments

Hydrotherapy Massage Experience

Strategically positioned massage jets help relieve muscle tension and promote overall relaxation

Comfortable Social Wellness Space

Designed for family gatherings and social spa enjoyment in a relaxed atmosphere

Elegant Outdoor Spa Design

Clean architectural lines and modern cabinet styling enhance terraces, gardens, and outdoor leisure areas

SOCIAL ENTERTAINMENT SPA



The WH03 is crafted for immersive hydrotherapy and comfortable body relaxation.

Its ergonomic interior and massage configuration create a perfect space for daily wellness, muscle recovery and luxury spa enjoyment.

Technical Specifications

Item	Specification
Product Code	07030105
Model	WH05
Dimensions	2690 × 2090 × 930 mm
Product Type	Social Spa
Application	Relaxation · Family Use · Entertainment

Key Features

Spacious Family Layout

Large interior space allows multiple users to relax comfortably and enjoy shared spa moments

Hydrotherapy Massage Experience

Strategically positioned massage jets help relieve muscle tension and promote overall relaxation

Comfortable Social Wellness Space

Designed for family gatherings and social spa enjoyment in a relaxed atmosphere

Elegant Outdoor Spa Design

Clean architectural lines and modern cabinet styling enhance terraces, gardens, and outdoor leisure areas

PREMIUM FAMILY HYDROTHERAPY SPA

The WH06 is designed to provide a comfortable and balanced spa experience for family relaxation and daily wellness.

Its spacious square layout and ergonomic seating create an inviting environment for hydrotherapy, leisure and premium outdoor living.



Technical Specifications

Item	Specification
Product Code	07030106
Model	WH06
Dimensions	2120 × 2120 × 900 mm
Product Type	Family Hydrotherapy Spa
Application	Relaxation · Hydrotherapy · Family Wellness

Key Features

Comfortable Multi-Seat Layout

The spacious square configuration allows several users to relax comfortably and enjoy the spa together

Hydrotherapy Massage Experience

Strategically positioned massage jets help ease muscle tension and promote overall body relaxation

Balanced Wellness Design

Designed for everyday relaxation, wellness recovery, and family leisure time

Elegant Outdoor Spa Styling

Clean architectural lines and refined cabinet design complement modern terraces, gardens, and outdoor spaces

COMPACT LUXURY SPA



The WH07 is designed for compact outdoor spaces while still delivering a refined hydrotherapy experience. Its square layout and comfortable seating create an inviting environment for personal relaxation and everyday wellness.

Technical Specifications

Item	Specification
Product Code	07030107
Model	WH07
Dimensions	2100 × 1800 × 850 mm
Product Type	Compact Spa
Application	Relaxation · Hydrotherapy · Private Wellness

Key Features

Comfortable Multi-Seat Layout

The spacious square configuration allows several users to relax comfortably and enjoy the spa together.

Hydrotherapy Massage Experience

Strategically positioned massage jets help ease muscle tension and promote overall body relaxation.

Balanced Wellness Design

Designed for everyday relaxation, wellness recovery and family leisure time.

Elegant Outdoor Spa Styling

Clean architectural lines and refined cabinet design complement modern terraces, gardens and outdoor spaces.

COMPACT FAMILY SPA

The WH08 is designed to provide a comfortable hydrotherapy experience in a compact and elegant spa format. Its balanced layout offers an inviting environment for relaxation, wellness recovery and everyday outdoor enjoyment.



Technical Specifications

Item	Specification
Product Code	07030108
Model	WH08
Dimensions	1800 × 1600 × 890 mm
Product Type	Compact Family Spa
Application	Relaxation · Hydrotherapy · Family Wellness

Key Features

Compact Square Layout

The space-efficient design fits easily into patios, gardens and smaller outdoor relaxation areas.

Hydrotherapy Massage Experience

Strategically positioned massage jets help relieve muscle tension and support daily wellness.

Comfortable Multi-User Seating

The interior seating arrangement allows several users to relax together comfortably.

Modern Outdoor Spa Design

Clean architectural lines and stylish cabinet finishes complement contemporary outdoor living spaces.

PATIO WELLNESS SPA



The WH09 is designed for modern outdoor living spaces where comfort and style are equally important. Its practical layout and refined appearance make it ideal for private patios, terraces and residential wellness areas.

Technical Specifications

Item	Specification
Product Code	07030109
Model	WH09
Dimensions	2000 × 1600 × 950 mm
Product Type	Patio Spa
Application	Relaxation · Hydrotherapy · Private Wellness

Key Features

Space-Efficient Spa Design

The compact footprint allows flexible installation in smaller outdoor environments.

Relaxing Hydrotherapy Experience

Massage jets provide soothing hydrotherapy to help relieve daily stress and muscle fatigue.

Comfortable Seating Arrangement

Ergonomic seating supports a relaxing spa experience for individuals or small groups.

Contemporary Outdoor Styling

Elegant cabinet design and clean lines blend seamlessly with modern outdoor architecture.

PREMIUM FAMILY SPA

The WH10 is designed to deliver a comfortable and spacious hydrotherapy experience for family relaxation and shared wellness. Its balanced square layout and elegant design create an inviting spa environment for modern outdoor living.

Technical Specifications

Item	Specification
Product Code	07030110
Model	WH10
Dimensions	2000 × 2000 × 1000 mm
Product Type	Family Spa
Application	Relaxation · Hydrotherapy · Family Wellness



Key Features

Spacious Square Layout

The generous interior space allows several users to enjoy the spa comfortably together.

Hydrotherapy Massage Experience

Strategically positioned massage jets help relieve muscle tension and promote overall relaxation.

Family Wellness Design

Designed for daily relaxation, hydrotherapy recovery, and enjoyable family spa moments.

Modern Outdoor Styling

Clean architectural lines and refined cabinet finishes enhance patios, gardens, and residential outdoor spaces.

MODERN RESIDENTIAL SPA



The WH11 is crafted to provide a relaxing hydrotherapy experience with a refined and contemporary appearance. Its practical layout and elegant design make it ideal for private residential wellness spaces.

Technical Specifications

Item	Specification
Product Code	07030111
Model	WH11
Dimensions	2000 × 2000 × 960 mm
Product Type	Residential Spa
Application	Relaxation · Hydrotherapy · Private Wellness

Key Features

Balanced Spa Layout

The square configuration offers comfortable seating and efficient use of interior space

Hydrotherapy Massage Experience

Massage jets provide soothing water therapy to help relieve daily stress and muscle fatigue

Comfortable Multi-User Seating

Designed to accommodate several users while maintaining a comfortable spa environment

Elegant Outdoor Design

Modern cabinet styling and clean lines blend naturally with contemporary outdoor architecture

LUXURY LOUNGE SPA

The WH12 is designed to create a luxurious hydrotherapy experience with generous interior space and elegant styling. Its larger spa format provides an ideal environment for relaxation, wellness recovery and premium outdoor living.



Technical Specifications

Item	Specification
Product Code	07030112
Model	WH12
Dimensions	2200 × 2200 × 960 mm
Product Type	Luxury Spa
Application	Relaxation · Hydrotherapy · Social Wellness

Key Features

Spacious Lounge Layout

The expanded interior space allows multiple users to relax comfortably in a social spa environment

Deep Hydrotherapy Relaxation

Massage jets deliver soothing hydrotherapy to help relieve muscle tension and promote overall wellness

Comfortable Family Experience

Perfect for shared relaxation, family gatherings and weekend spa enjoyment

Premium Outdoor Appearance

Elegant cabinet finishes and refined design enhance upscale outdoor living spaces

DESIGNER SOAKING SPA



The WH13 is designed to combine minimalist aesthetics with a relaxing soaking experience. Its clean rectangular form and refined layout create a luxurious bathing environment for modern residential wellness spaces.

Technical Specifications

Item	Specification
Product Code	07030113
Model	WH13
Dimensions	1800 × 1700 × 750 mm
Optional	2000 × 1930 × 750 mm
Product Type	Designer Soaking Spa
Application	Relaxation · Soaking · Residential Wellness

Key Features

Elegant Soaking Design

The elongated layout provides a comfortable soaking experience for relaxation and recovery

Minimalist Architectural Style

Clean lines and contemporary finishes complement modern interior and outdoor environments

Relaxing Hydrotherapy Experience

Integrated jets create gentle water movement for a soothing bathing experience

Versatile Installation Options

Suitable for private gardens, terraces and luxury residential wellness areas

ROUND SOCIAL SPA

The WH14 features a distinctive circular design that creates a unique social spa experience. Its spacious round layout encourages relaxation and conversation while enjoying soothing hydrotherapy.



Technical Specifications

Item	Specification
Product Code	07030114
Model	WH14
Dimensions	2450 × 2450 × 1100 mm
Product Type	Round Spa
Application	Social Relaxation · Hydrotherapy · Outdoor Wellness

Key Features

Unique Round Layout

The circular spa design creates a comfortable and interactive social wellness environment

Spacious Relaxation Area

Ample interior space allows multiple users to enjoy the spa together

Hydrotherapy Massage Experience

Strategically positioned jets help relieve muscle tension and enhance relaxation

Luxury Outdoor Appearance

Elegant cabinet styling makes the spa a striking feature in gardens and outdoor leisure spaces

COMPACT ROUND SPA

The WH15 is designed as a compact round spa that combines comfort with space efficiency. Its elegant circular form creates a relaxing bathing experience suitable for private residential wellness spaces.

Technical Specifications

Item	Specification
Product Code	07030115
Model	WH15
Dimensions	1600 × 1600 × 630 mm
Optional 1	1800 × 1800 × 630 mm
Optional 2	2000 × 2000 × 840 mm
Optional 3	2000 × 2000 × 630 mm
Product Type	Compact Round Spa
Application	Relaxation · Hydrotherapy · Private Wellness



Key Features

Compact Round Design

The circular layout provides a comfortable spa experience while maintaining a small footprint

Relaxing Hydrotherapy Experience

Massage jets deliver gentle water therapy for relaxation and stress relief

Massage jets deliver gentle water therapy for relaxation and stress relief

Ideal for terraces, patios and small outdoor wellness areas

Modern Residential Styling

The refined cabinet finish integrates beautifully with contemporary outdoor design

AQUAFIT EVOLUTION SERIES

FAMILY SWIM TRAINER



Featured Highlights

- **Effortless Installation** – Four screws, ready to swim in minutes
- **Smooth, Whisper-Quiet Currents** – Perfect for family enjoyment
- **Elegant Design** – Silver or white, harmonizing with any home pool
- **Instant Wellness & Fun** – Swim, train and elevate your lifestyle

Ordering Information

Product	Model	Color	Description
07040101	AFE01	Pure White	1.65KW 220V/24V 12-Level Flow Adjustment
07040102	AFE02	Elegant Silver	1.65KW 220V/24V 12-Level Flow Adjustment

For additional product requirements, please feel free to contact us.



Watch (Standard)



Round Control Panel (Standard)



Oval Control Panel (Optional)

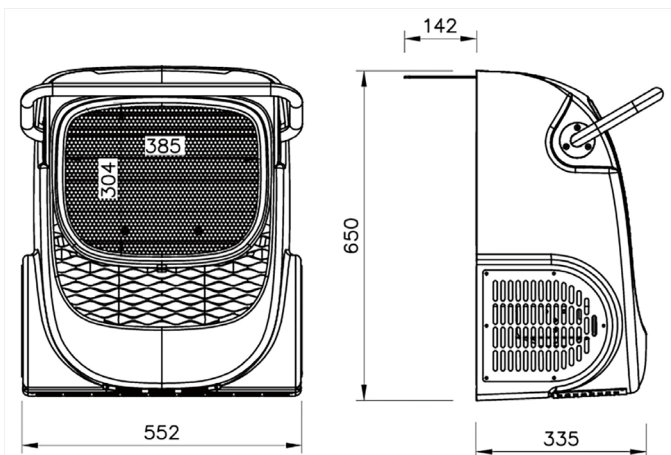

Overall Dimensions

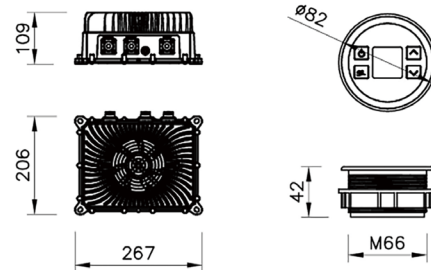

Installation Diagram

AQUAFIT EVOLUTION SERIES

ELITE SWIM TRAINER

Featured Highlights

- **Quick Four-Screw Installation** – Ready to swim in minutes
- **High-Power Motor** – Strong, adjustable currents for all levels
- **Professional Training Performance** – Suitable for athletes and lifeguards
- **Durable Weather-Resistant Acrylic Housing** – Stable outdoor operation
- **Instant Fitness & Lifestyle** – Swim, train, and embrace a healthy routine



Ordering Information

Product	Model	Color	DESCRIPTION
07040103	AFE03	Pure White	2.8KW 220V 12-Level Flow Adjustment White
For additional product requirements, please feel free to contact us.			



Watch (Standard)



Round Control Panel (Standard)



Oval Control Panel (Optional)

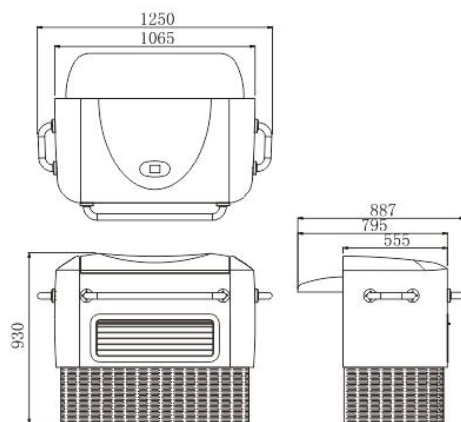

Overall Dimensions

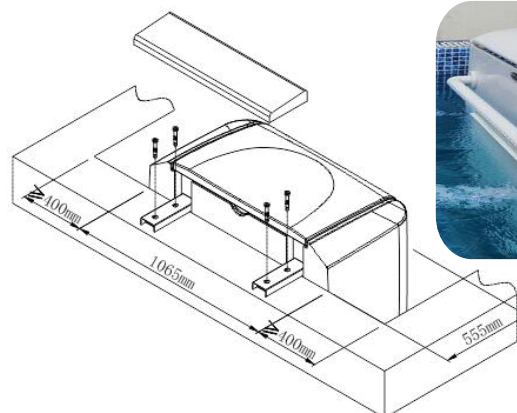

Installation Diagram



AQUAFIT EVOLUTION SERIES

HYDRO FITNESS TREADMILL

Featured Highlights

- Effortless Pool Setup – Quick, easy installation
- Smart Wireless Control – Panel or wearable bracelet
- Customizable Speeds – 12-level smooth adjustment
- Safe & Reliable – Low-voltage DC drive
- Auto Protection – Shuts down after 45min
- Gentle Muscle Workout – Strengthens legs, reduces impact



Inflatable Pool + Underwater Treadmill



Watch



Control Panel



Touch Large-screen LCD

Ordering Information

Product	Model	Input Voltage	Operating Voltage	Description
07040104	AFE04	AC110-240V	DC24V	1.65KW 220V/24V 12-Level Flow Adjustment

For additional product requirements, please feel free to contact us.

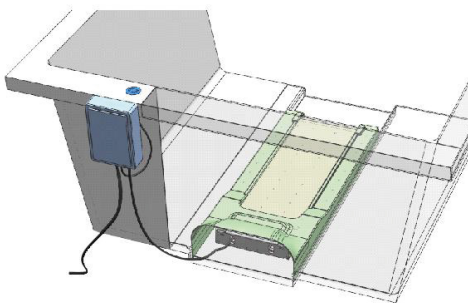
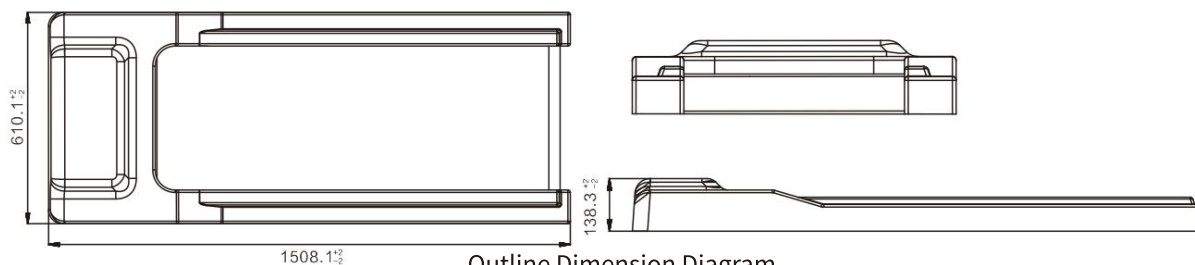

WATERWAVE AQUA MOTION SERIES

HEALTHY MOTION POWERED BY WATER

Featured Highlights

- Tool-Free / Easy Installation
- Low-Impact Aquatic Training
- Heavy-Duty & Corrosion-Resistant Design
- Designed for a Healthy Lifestyle



Ordering Information

Product	Model	Description	Material	Installation Type
07050201	WAM01	Underwater Bike	SS316 & Acrylic	Fixed/Deck-Mounted

For more product information and customization options, please contact us.

WATERWAVE AQUA MOTION SERIES

HEALTHY MOTION POWERED BY WATER



Featured Highlights

- Tool-Free / Easy Installation
- Low-Impact Aquatic Training
- Heavy-Duty & Corrosion-Resistant Design
- Designed for a Healthy Lifestyle

Ordering Information

Product	Model	Description	Material	Installation Type
07050202	WAM02	Pool Basketball Rack	SS316 & Acrylic	Fixed/Deck-Mounted

For more product information and customization options, please contact us.

Overall Dimension

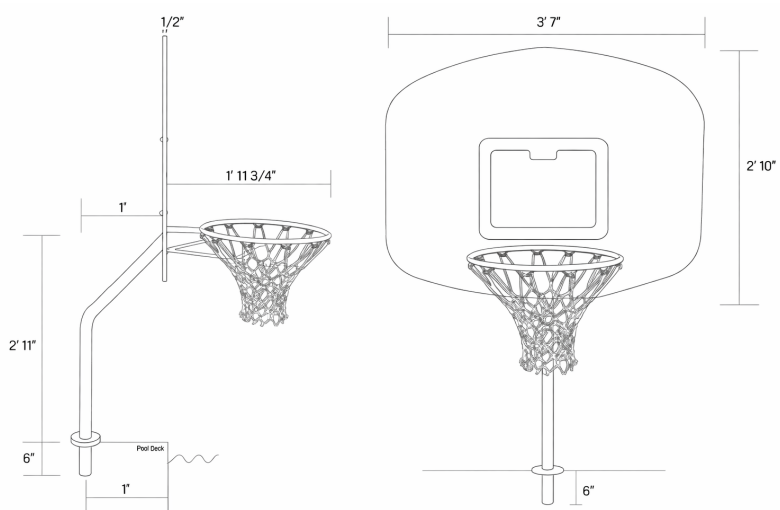

WATERWAVE AQUA MOTION SERIES

HEALTHY MOTION POWERED BY WATER

Featured Highlights

- Tool-Free / Easy Installation
- Low-Impact Aquatic Training
- Heavy-Duty & Corrosion-Resistant Design
- Designed for a Healthy Lifestyle



Ordering Information

Product	Model	Description	Material	Dimension
07050203	WAM03	Pool Volleyball Rack	SS316	Length 4'5"
For more product information and customization options, please contact us.				

Overall Dimension

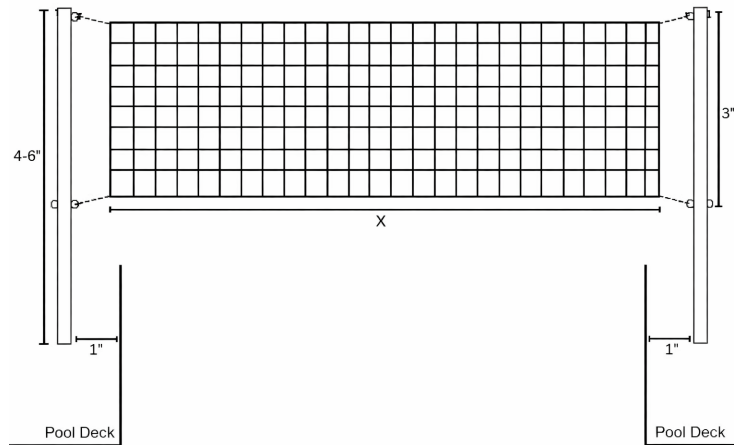



WATERWAVE

COMPETITION ACCESSORIES









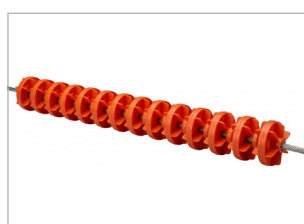
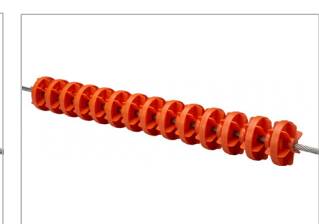

PROAQUA ELITE SERIES

ENGINEERED FOR COMPETITIVE PERFORMANCE

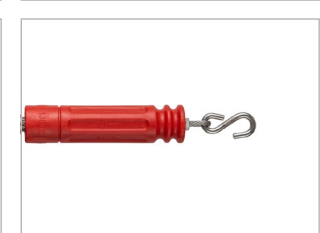
Featured Highlights

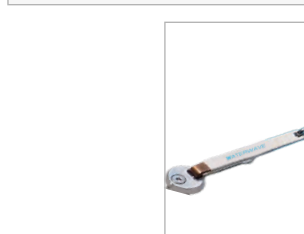
- Proven in multiple international events
- Engineered for precision and stability
- High-strength materials for long-term durability
- Optimized for athlete performance
- Strict quality control & professional-grade standards

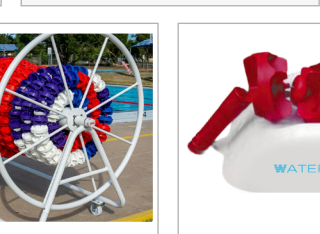
			
<p>PAE101 08010101</p> <p>ProAqua Elite Racing Lane 110mm Diameter 25m</p>	<p>PAE102 08010102</p> <p>ProAqua Elite Racing Lane 110mm Diameter 50m</p>	<p>PAE103 08010103</p> <p>ProAqua Elite Racing Lane 130mm Diameter 25m</p>	<p>PAE104 08010104</p> <p>ProAqua Elite Racing Lane 130mm Diameter 50m</p>
			
<p>PAE105 08010105</p> <p>ProAqua Elite Racing Lane 150mm Diameter 25m</p>	<p>PAE106 08010106</p> <p>ProAqua Elite Racing Lane 150mm Diameter 50m</p>	<p>PAE107 08010107</p> <p>Lane Tensioner With Short Clamp Set</p>	<p>PAE108 08010108</p> <p>Lane Achor SS316</p>
			
<p>PAE109 08010109</p> <p>Overflow Lane Anchor (Wet deck) SS316</p>	<p>PAE110 08010110</p> <p>Lane Storage Reel SS316 2*50m Racing Lane</p>	<p>PAE111 08010111</p> <p>Durable Reinforced FRP Racing Lane Saver</p>	

PROAQUA ELITE SERIES

ENGINEERED FOR COMPETITIVE PERFORMANCE

Featured Highlights

- Proven in multiple international events
- Engineered for precision and stability
- High-strength materials for long-term durability
- Optimized for athlete performance
- Strict quality control & professional-grade standards



PAE201
08020101

World-Class Competition Starting Block 790*625mm



PAE202
08020102

Competition-Standard Starting Block 735*535mm



PAE203
08020103

Standard Training Starting Block with Blue Anti-Slip Platform 600*500mm



PAE204
08020104

Standard Training Starting Block with White Anti-Slip Platform 600*500mm



PAE205
08020105

Elite Modular Competition End Wall 2500*1000*300mm



PAE206
08020106

Elite Modular Competition End Wall 2500*850*300mm

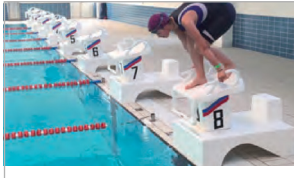

PAE207
08020107

Elite Overflow Blockstands 1000*800*300mm

For additional product requirements, please feel free to contact us.

PROAQUA ELITE SERIES

ENGINEERED FOR COMPETITIVE PERFORMANCE

Featured Highlights

- Proven in multiple international events
- Engineered for precision and stability
- High-strength materials for long-term durability
- Optimized for athlete performance
- Strict quality control & professional-grade standards



PAE301

08030101

Elite Back Stroke Pole & Flag Set

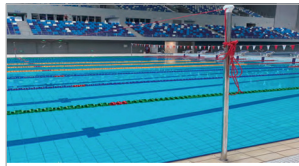

PAE302

08030102

False Start Poles & Rope Set

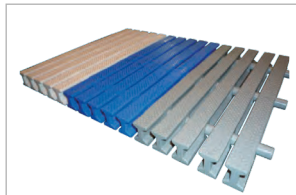

PAE303

08030103

Longitudinal Overflow Grating
250/300/350/400/450mm

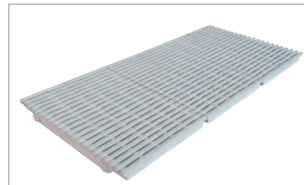

PAE304

08030104

Horizontal Overflow Grating
200/250/300/350/400mm



PAE305

080310105

Modular Grating
200/250/300/350/400mm

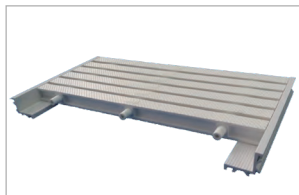

PAE306

08030106

Overflow Grating Edge Rail Height
25mm, Length 1m



PAE307

08030107

International Competition-Grade
Water Polo Goal



PAE308

08030108

Club-Level Folding Water Polo
Goal

For additional product requirements, please feel free to contact us.



WATERWAVE

SAFETY COVER

- ◆ **SLATTED POOL COVER**
- ◆ **INTEGRATED POOL COVER**
- ◆ **FLEXIBLE POOL COVER**
- ◆ **POOL DECK COVER**
- ◆ **ELEVATING POOL COVER**

AQUASHIELD SAFETY COVER SERIES

AUTOMATIC SLATTED POOL COVER SYSTEM



Color Options: White, Brown

Featured Highlights

- Fully Automatic Operation – One-touch control for effortless daily use
- Thermal Insulation – Maintains pool temperature and enhances energy efficiency
- Debris Protection – Prevents leaves, dust and contaminants from entering the pool
- Safety Barrier – Helps prevent children from accidentally falling into the pool
- Reduced Heat Loss & Evaporation – Minimizes water and heat loss for lower operating costs

Ordering Information

Product	Model	Slat Material	Max. Pool Size	Max. Load Capacity	Input Voltage	Operating Voltage	Installation Type
09010101	ASF001	Aluminum Alloy Foam	Max. Width: 3.5m (11.5ft) Max. Length: 12m (39.4ft)	20kg/m ²	AC220V	DC24V	Roller Cover

For more product information and customization options, please contact us.

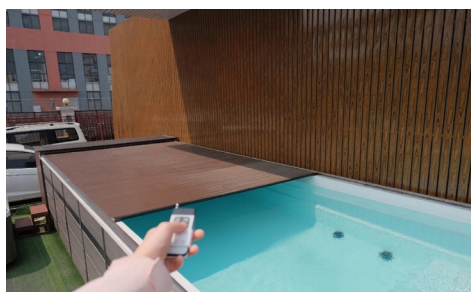

Remote Control

AQUASHIELD SAFETY COVER SERIES

INTEGRATED POOL COVER SYSTEM



Slat Colors Available: Transparent Blue, Transparent Black, White

Featured Highlights

- Effortless Above-Pool Installation – Floats smoothly on the water surface
- Premium Hollow PC Panels – Superior thermal insulation and durability
- Weather & UV Resistant – Built to last in all climates
- Clean & Safe – Blocks debris and protects children
- Energy Efficient – Minimizes heat loss and water evaporation

Ordering Information

Product	Model	Slat Material	Max. Pool Size	Max. Load Capacity	Input Voltage	Operating Voltage	Installation Type
09010102	ASF002	PC	Max. Width: 8m (26.2ft) Max. Length: 28m (91.9ft)	50kg/m ²	AC220V	DC24V	Above or Below Water

For more product information and customization options, please contact us.



AQUASHIELD SAFETY COVER SERIES

AUTOMATIC FLEXIBLE POOL COVER SYSTEM

Featured Highlights

- Effortless End-Mounted Installation – Floats smoothly on the water surface
- Premium PVC Material – Durable, weather-proof and UV resistant
- Clean & Safe – Blocks debris and protects children
- Energy Efficient – Minimizes heat loss and water evaporation



Ordering Information

Product	Model	Slat Material	Max. Pool Size	Max. Load Capacity	Input Voltage	Installation Type
09010103	ASF003	PVC Film	Max. Width: 6.5m (21.3ft) Max. Length: 25m (82.0ft)	150kg/m ²	DC220V	Above-Ground/ In-Ground Installation

For more product information and customization options, please contact us.

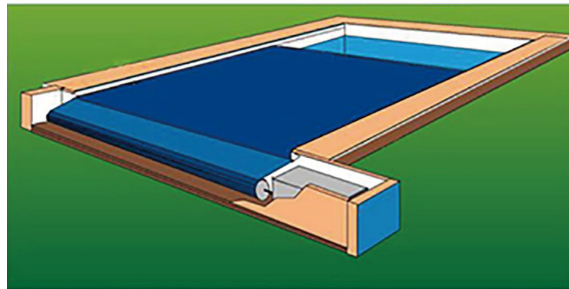

AQUASHIELD SAFETY COVER SERIES

SLIDING POOL DECK COVER SYSTEM

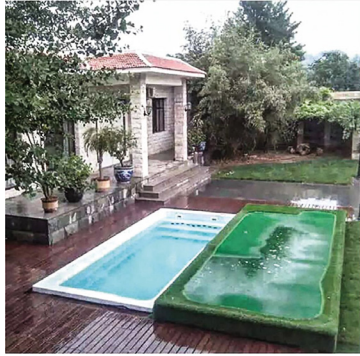

Featured Highlights

- Effortless Above-Pool Operation – Smooth back-and-forth movement
- Smart Storage Design – Requires reserved space equal to cover size
- Premium Construction – Insulated stainless steel core with aluminum exterior
- Customizable Finish – Decorative turf or weather-resistant wood options
- Robust & Safe – Supports up to 150kg/m², blocks debris and protects children
- Energy Efficient – Minimizes heat loss and water evaporation

Ordering Information

Product	Model	Slat Material	Max. Pool Size	Max. Load Capacity	Input Voltage	Operating Voltage	Installation Type
09010104	ASF004	Steel Structure	Max. Width: 7m (23.0ft) Max. Length: 20m (65.6ft)	150kg/m ²	AC220V	DC24V	Rail-Mounted Sliding

For more product information and customization options, please contact us.



AQUASHIELD SAFETY COVER SERIES

AUTOMATIC ELEVATING POOL COVER SYSTEM

Featured Highlights

- One-Button Operation – Opens/closes in 30 seconds
- Debris Protection – Blocks leaves, snow and dirt
- Private & Comfortable – Creates a cozy swimming space
- Smart & Safe – Convenient intelligent control



Ordering Information

Product	Model	Slat Material	Max. Pool Size	Max. Load Capacity	Input Voltage	Operating Voltage	Installation Type
---------	-------	---------------	----------------	--------------------	---------------	-------------------	-------------------

09010105	ASF005	Aluminum Alloy & WPC Boards	Max. Width: 3m (9.8ft) Max. Length: 12m (39.4ft)	200kg/m ²	AC110-220V	DC24V	Floor-Mounted
----------	--------	-----------------------------	---	----------------------	------------	-------	---------------

For more product information and customization options, please contact us.



 WATERWAVE

MODULAR PANEL POOL



THE FUTURE OF POOL CONSTRUCTION – WATERWAVE MODULAR PANEL POOL

Traditional swimming pool construction has long been associated with significant challenges. Conventional concrete pools often require extended construction periods, leading to project delays and higher labor costs.

Budget control can also become difficult due to on-site uncertainties, while long-term maintenance tends to be complex and costly, especially when structural issues or leaks occur.



THE MODULAR PANEL POOL SYSTEM IS DESIGNED TO OVERCOME THESE LIMITATIONS BY OFFERING A SMARTER, MORE EFFICIENT ALTERNATIVE

With a modular approach, all components are prefabricated and assembled on-site, significantly improving efficiency and quality control

KEY ADVANTAGES:

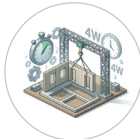

Fast Construction (2–4 weeks):

Prefabricated panels allow rapid installation, reducing project timelines by up to 70%



Lower Initial Investment

Optimized manufacturing and reduced on-site labor help control upfront costs



Reusable & Relocatable:

The system can be dismantled and reinstalled, maximizing lifecycle value



Modular Installation:

Flexible design adapts easily to different site conditions and project needs



Low Maintenance Cost:

Low Maintenance Cost: Durable materials and simplified structure minimize long-term maintenance requirements

Thanks to these advantages, WATERWAVE Modular Panel Pool systems are becoming a preferred solution across a wide range of applications:

- ✓ **Commercial Pools:**
Ideal for developers seeking fast ROI and efficient construction
- ✓ **Hotels & Resorts:**
Flexible design to match various architectural styles
- ✓ **Schools & Institutions:**
Safe, cost-effective, and easy to maintain
- ✓ **Training & Competition Pools:**
Engineered to meet professional standards and performance requirements

As the demand for faster, more sustainable, and cost-effective construction continues to grow, Modular Panel Pool systems are rapidly emerging as the future direction of the swimming pool industry.

STRUCTURAL SYSTEM



Panel Structure

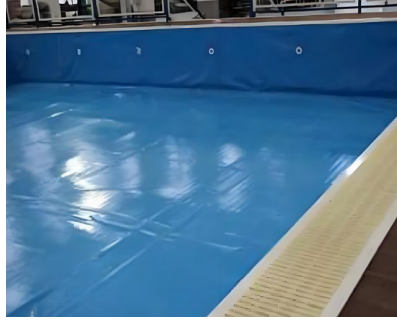

PVC Liner



Overflow Gutter



Inlet / Outlet



Handrail



Staircase



Safety Railing

The following configurations are for reference

Pool Type	Size	Depth	Min Area	Recommended Facility Area	Analysis
Standard Pool	50 × 25 m	≤ 1.35 m	1500 m ²	320 m ²	Large footprint and higher investment Suitable for large-scale water parks and high-end hotels
Standard Pool	25 × 15 m	≤ 1.2 m	500 m ²	100 m ²	Moderate footprint and investment Easy to manage, suitable for schools and most community pools
Standard Pool	15 × 10 m	≤ 0.8 m	250 m ²	100 m ²	Small footprint and low investment Easy to install and maintain especially suitable for kindergartens
Standard Competition Pool	50 × 25 m	≤ 1.8 m	Customized based on competition standards and user requirements	Customized	Designed according to competition standards and specific project requirements
Non-standard Pool	Customized	Customized	Customized	Customized	Designed according to site conditions and client requirements

TOP VIEW

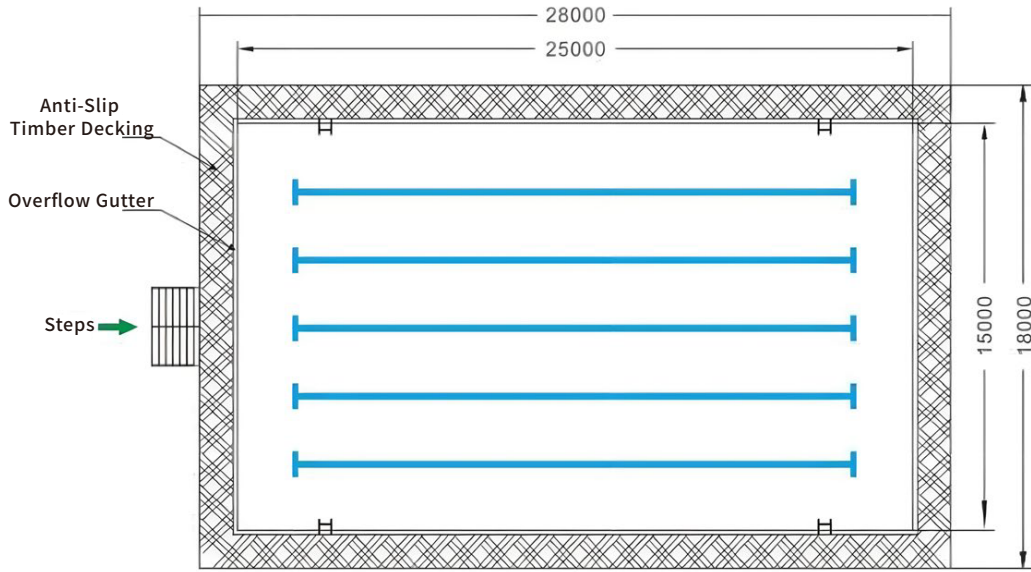

SECTION

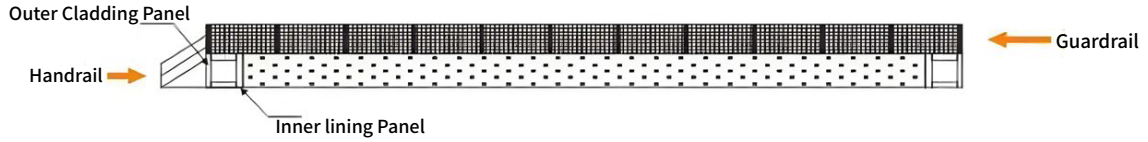

SWIMMING POOL AUXILIARY ROOM LAYOUT

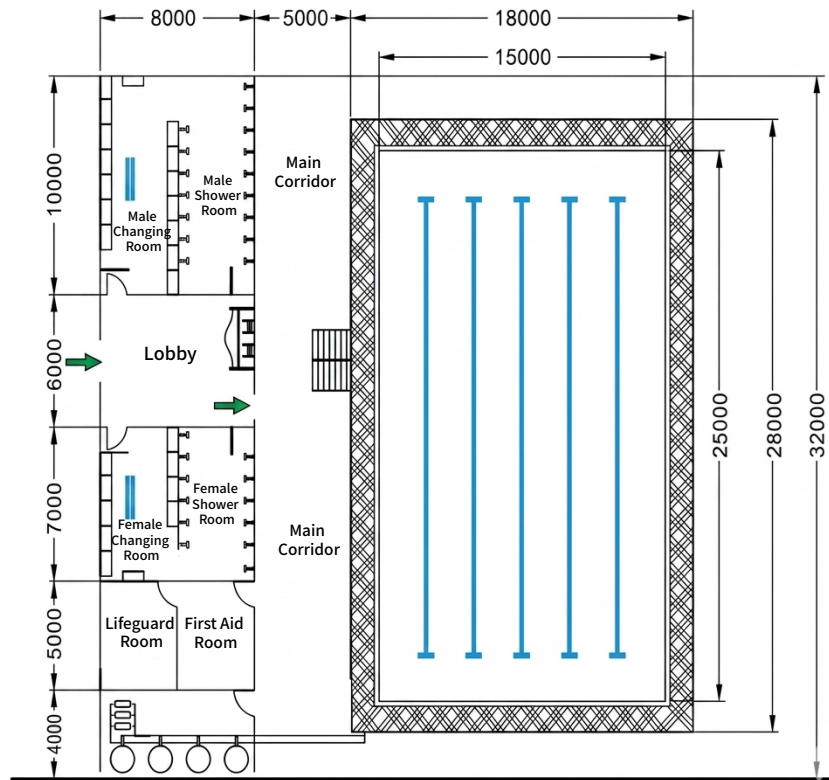

ONE SYSTEM ONE SUPPLIER ONE RESPONSIBILITY

COMPLETE INTEGRATED POOL SYSTEM SOLUTION

We provide a fully integrated pool system covering:

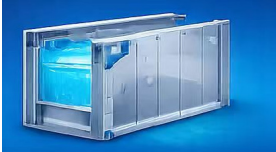

Panel Structure System
Modular & Durable Pool Body



Filtration System
High-Efficiency Water Treatment



Circulation System
Optimal Water Flow Technology



Disinfection System
PH,OTO&ORP Management



Heating /cooling System
Reliable Pool Temperature Control



Lighting System
Brilliant LED Underwater Lllumination

Turnkey Delivery Capability
From design to commissioning — fully managed under one responsibility



Turnkey Solution



Compatible with
local standards



Integrated system
responsibility

TECHNICAL CONVERSION CHART

Length	Inch (in)	Foot (ft)	Meter (m)
Inch (in)	1	0.083	0.025
Foot (ft)	12	1	0.305
Meter (m)	39.37	3.281	1

Area	Square inch (in ²)	Square foot (ft ²)	Square meter (m ²)	Square centimeter (cm ²)
Square inch (in ²)	1	0.0069	0.000645	6.45
Square foot (ft ²)	144.036	1	0.093	929.03
Square meter (m ²)	1150.388	10.764	1	10
Square centimeter (cm ²)	0.155	0.00107	0.0001	1

Capacity / Volume	Square inch (in ³)	U.S. gallon (US gal)	Cubic meter (m ³)	Liter (l)
Imperial gallon (UK gal)	1	1.201	0.0045	6.45
U.S. gallon (US gal)	0.833	1	0.0038	929.03
Cubic meter (m ³)	264.172	219.969	1	10
Liter (l)	0.22	0.264	0.001	1

Mass / Weight	Pound (lb)	Kilogram (kg)	Gram (g)
Pound (lb)	1	0.454	453.59
Kilogram (kg)	2.205	1	1000
Gram (g)	0.0022	0.001	1

Pressure	Pounds per square inch (psi)	Bar (bar)	Pascal (pa)	KG per square cm (kg/cm ²)
Pounds per square inch (psi)	1	0.0689	6894.76	0.07
Bar (bar)	14.504	1	100000	1.019
Pascal (pa)	0.00014	0.00001	1	0.0001
KG per square cm (kg/cm ²)	14.228	0.981	98100	1

Power	British Thermal Unit/hour (BTU/h)	Horsepower (HP)	Kilowatt (kW)
British Thermal Unit/hour (BTU/h)	1	0.00039	0.00029
Horsepower (HP)	2544.43	1	0.746
Kilowatt (kW)	3412.14	1.341	1

Velocity	Inch/second (in/s)	Foot/second (ft/s)	Meter/second (m/s)	Meter/hour (m/h)
Inch/second (in/s)	1	0.083	0.025	91.44
Foot/second (ft/s)	12	1	0.305	1097.28
Meter/second (m/s)	39.37	3.281	1	3600
Meter/hour (m/h)	0.011	0.00091	0.00028	1

Flow	US gallon / minute (US gal/min)	UK gallon / minute (UK gal/min)	Cubic meters / hour (m ³ /h)	Liters / second (l/s)
US gallon/minute (US gal/min)	1	1.201	0.273	0.076
UK gallon/minute (UK gal/min)	0.833	1	0.227	0.063
Cubic meters/hour (m ³ /h)	3.667	4.403	1	0.278
Liters/second (l/s)	13.198	15.85	3.6	1

Temperature	Degree Celsius (°C)	Fahrenheit (°F)
Degree Celsius (°C)	1	32+[(9/5)x°C]
Fahrenheit (°F)	(5/9) x (°F-32)	1

GUANGZHOU YONGZHAO TRADING CO.,LTD

◆ WEBSITE:www.waterwaveglobal.com

◆ EMAIL:admin@waterwaveglobal.com

ADD ROOM 301, UNIT B603, 6TH FLOOR, SCIENTIFIC AND OFFICE BUILDING, NO. 2
XINCEN 4TH ROAD, TIANHE DISTRICT, GUANGZHOU CITY, CHINA